

# OutBack Power Systems

## MX60 PV MPPT Charge Controller



## INSTALLATION AND USER'S MANUAL

Please read this entire manual prior to installing and using  
the MX60 PV MPPT Charge Controller

OutBack Power Systems, INC  
19009 62nd Ave NE  
Arlington, WA 98223. USA  
Telephone: (360) – 435 – 6030

900-0028-1 REV 6.2  
Serial #s 5500 and greater  
Copyright © 2004, 2005  
OutBack Power Systems, INC  
[www.outbackpower.com](http://www.outbackpower.com)



# EU DECLARATION OF CONFORMITY

According to ISO / IEC Guide 22 and EN 45014

**Product Type:** Photovoltaic Charge Controller

**Product Model Number:** MX60

This product complies with the following EU directives:

**Electromagnetic Compatibility 89/336/EEC, “Council Directive of 3 May 1989**

On the approximation of the laws of member States relating to Electromagnetic compatibility”

**Low Voltage Directive 73/23/EEC, “Council Directive of 19 February 1973** on the harmonization of the laws of Member States relating to electrical equipment for use within certain voltage limits”

The compliance of the above mentioned product with the directives and the following essential requirements is hereby confirmed:

|                   |                   |                                |
|-------------------|-------------------|--------------------------------|
| Emissions         | Immunity          | Safety                         |
| EN 50081-1 (1992) | EN 50082-1 (1992) | EN 60335-1 Battery Chargers    |
|                   |                   | EN 60335-2-29 Battery Chargers |

All associated technical files are located in the Engineering Department at OutBack Power Systems Inc., Arlington, Washington, USA.

As the manufacturer we declare under our sole responsibility that the above mentioned product complies with the above named directives.

Robin Gudgel  
President

Arlington, WA, USA 03 August 2003  
Place and Date



19009 62<sup>nd</sup> Ave. NE  
Arlington, WA. 98223 USA

## TABLE OF CONTENTS

|  |           |
|--|-----------|
| IMPORTANT SAFETY INSTRUCTIONS .....  | 6         |
| INTRODUCING THE OUTBACK MX60 PV MPPT CONTROLLER .....                                  | 6         |
| <b>MAXIMUM OPEN CIRCUIT VOLTAGE AND COLD AMBIENT TEMPERATURE .....</b>                 | <b>7</b>  |
| INSTALLATION .....   | 8         |
| MOUNTING THE MX60 .....  | 8         |
| WIRE AND DISCONNECT SIZING .....   | 9         |
| WIRE DISTANCE CHART .....  | 10        |
| SURGE PROTECTION .....   | 11        |
| FIELD WIRING CONNECTIONS .....   | 11        |
| SYSTEM CONFIGURATION .....   | 13        |
| <b>Battery System Voltage .....</b>  | <b>13</b> |
| <b>Resetting to Factory Default .....</b>  | <b>13</b> |
| POWER UP SCREEN .....  | 14        |
| STATUS SCREEN .....  | 14        |
| MAIN MENU .....  | 15        |
| <b>CHARGER SETUP .....</b>   | <b>15</b> |
| <b>AUX OUTPUT CONTROL .....</b>  | <b>16</b> |
| Aux Output Control -- Explained .....  | 16        |
| Manual .....   | 16        |
| Vent Fan .....   | 16        |
| PV Trigger .....   | 16        |
| Night Light .....  | 17        |
| Float or Output Current .....  | 17        |
| Error Alarm .....  | 17        |
| Diversion .....  | 17        |
| Diversion Volt .....   | 18        |
| Diversion Time .....   | 18        |
| Low Battery Disconnect .....   | 18        |
| LBD Disconnect/Reconnect Voltage .....   | 18        |
| Remote .....   | 19        |
| <b>BACKLIGHT CONTROL .....</b>   | <b>19</b> |
| <b>EQ -- BATTERY EQUALIZE .....</b>  | <b>19</b> |
| Manual Equalization Cycle .....  | 20        |
| Auto Equalization Cycle .....  | 20        |
| <b>MISC -- MISCELLANEOUS .....</b>   | <b>21</b> |
| Miscellaneous Screen -- Explained .....  | 21        |
| WIDE/LMIT Battery Temperature Compensated Limits .....                                 | 21        |
| Setting the Upper and Lower battery temperature compensated voltage range limits ..... | 22        |
| Force Bulk or Float .....  | 22        |

|  |           |
|--|-----------|
| Miscellaneous Screen 3 -- Explained.....                       | 23        |
| Absorb Ending Amps Adjustment (EndA).....                      | 23        |
| <b>OPTIMIZATION .....</b>                                      | <b>24</b> |
| Snooze Mode .....  | 24        |
| Park Mpp % (Voc).....  | 24        |
| Mpp Range Limit % Voc (Auto Sweep mode only).....              | 25        |
| Sweep Interval .....   | 25        |
| Vbatt Calibration (Output/Battery Voltage display Offset)..... | 26        |
| Low Cutoff.....  | 26        |
| MPPT Mode Select (Auto Sweep or U_Pick) .....                  | 27        |
| FX-GT/non-GT.....  | 27        |
| Absorb Time Limits and Charge Timer.....                       | 27        |
| Aux Polarity (Active High / Active Low).....                   | 28        |
| <b>(DATA) LOGGING .....</b>                                    | <b>28</b> |
| Clearing Totals and Daily Stats .....                          | 28        |
| <b>LOG2.....</b>   | <b>29</b> |
| Secondary LOG2 Screen .....                                    | 30        |
| HighWatts .....  | 30        |
| Lo Hi (Lower, Upper Limits) .....                              | 30        |
| DCkWh/ACKWh.....   | 30        |
| APPLICATION NOTES.....   | 31        |
| Grid-tie applications .....                                    | 31        |
| Diversion using hydro or wind power .....                      | 31        |
| Positive grounded systems.....                                 | 31        |
| OutBack Power System GFX/GVFX Grid-tie settings.....           | 31        |
| Battery temperature compensation with other slopes .....       | 31        |
| CALLING THE FACTORY FOR ASSISTANCE .....                       | 32        |
| BASIC MX60 BLOCK DIAGRAM .....                                 | 32        |
| SPECIFICATION .....  | 33        |
| MX60 EFFICIENCY Vs. INPUT POWER GRAPH.....                     | 33        |
| APPENDIX A – OBDC GFP/2 INSTALLATION.....                      | 34        |
| APPENDIX B – WIRING DIAGRAM with FACTORY INSTALLED .....       | 35        |
| APPENDIX C – 120V BATTERY CHARGING APPLICATION .....           | 36        |
| APPENDIX D – UNDERSTANDING THE OPERATIONAL MODES .....         | 37        |
| APPENDIX F – TYPICAL ARRAY SIZING GUIDE.....                   | 41        |
| APPENDIX G – STANDARD vs. AUSTRALIAN DEFAULT SETTINGS.....     | 42        |
| APPENDIX 1 – MX60 MULTI-STAGE BATTERY CHARGING.....            | 43        |
| APPENDIX 2 – BATTERY TEMPERATURE COMPENSATED VOLATGE.....      | 44        |
| TWO YEAR LIMITED WARRANTY INFORMATION.....                     | 46        |
| REGISTER YOUR PRODUCT(S) .....                                 | 47        |

## IMPORTANT SAFETY INSTRUCTIONS

1. **SAVE THESE INSTRUCTIONS** – This manual contains important instructions for the MX60 Charge Controller that must be followed during installation and maintenance of the charge controller.
2. Torque the terminal block and ground terminals to **30 inch pounds / 4Nm**
3. Use a minimum of 8 AWG copper conductors only suitable for a minimum of 75 degrees C. The terminal block and ground terminal will accept up to 2 AWG conductors.
4. This symbol is used to identify chassis ground. 
5. This charge controller is intended to charge lead acid battery systems, sealed or vented with nominal voltages of 12, 24, 32, 36, 48, 54 or 60 volts DC. For other battery chemistries, contact the battery manufacturer for specific charger control settings and methodologies.
6. The MX60 PV MPPT Charge Controller is for **indoor** use only.

## INTRODUCING THE OUTBACK MX60 PV MPPT CONTROLLER

Your OutBack PV MX60 Maximum Power Point Tracking (MPPT) charge controller enables your PV system to achieve its highest possible performance by periodically tracking the Maximum Power Point of your array. \*

\* Please reference APPENDIX 1 for more information on the MX60 charge controller multi-stage battery charging.

Rated for up to 60 amps (default) of DC output current, the MX60 can be used with battery systems from 12v to 60v DC with up to 72v nominal PV array. The MX60's charger set points are fully adjustable to allow use with virtually any battery type, chemistry and charging profile.

The MX60 allows the use of a higher input PV array voltage with a lower battery voltage - such as charging a 24v DC battery with a 48v DC PV array. This reduces wire size and power loss from the PV array to the battery/inverter location and can maximize the performance of your PV system. This also ensures that the Maximum Power Point voltage is always above the battery voltage when the panels are warm/hot, which might make it harder to Equalize or keep the battery at a higher voltage when needed.

The MX60 comes standard with an easy to use and understand display of the system's performance. The four line, 80 character, backlit LCD display is also used for programming and monitoring of the battery system operation.

The MX60 can also be connected to the OutBack MATE system controller and display to allow monitoring of up to four or ten MX60 controllers (with the optional Hub 4 or Hub 10) from a distant location up to 1000 feet. The MATE also includes an Opto-isolated RS232 port for connection to a PC computer for data logging and system monitoring.

A built-in Auxiliary Output Control System can be used to control a secondary control circuit, relay or contactor. It can be used to control a diversion load, turn off loads when a low battery condition occurs, or other functions.

## MAXIMUM OPEN CIRCUIT VOLTAGE AND COLD AMBIENT TEMPERATURE

The maximum open circuit voltage of the PV array **must not** exceed 150v DC under any conditions or damage to the controller may occur. Furthermore, the maximum voltage level is recorded in the MX60's computer, allowing this level to be checked when seeking warranty service.

The MX60 will suspend operation if the PV array's open circuit voltage exceeds 135v DC. This helps to protect the controller from damage under very cold conditions. Most PV arrays will warm up significantly once sunlight is hitting the PV array - which then causes the PV array's voltage to drop and allowing the MX60 to resume operation.

The maximum voltage level is dependant on the brand/model of the solar panel, the number of solar panels connected in series, and on the temperature of the solar panels. The temperature depends on the system location and other local climatic conditions.

Solar arrays are usually comprised of solar panels connected in both parallel (+ to + / - to -) as well as in series (+ to -). This allows the same PV array to be configured for higher voltage / lower current or lower voltage / higher current. The total wattage of the array is the same either way - but higher voltage configuration can reduce wire size and losses, particularly if longer distances are involved. Panels can be connected in many different configurations, such as:

| Nominal Array Voltage | Number of panels in series                             | Expected open circuit voltage |
|-----------------------|--|-------------------------------|
| 48v DC                | Four 12v panels in series<br>Two 24v panels in series  | ~ 80v to ~ 100v               |
| 60v DC                | Five 12v panels in series                              | ~100v to ~ 120v               |
| 72v DC                | Six 12v panels in series<br>Three 24v panels in series | ~120v to ~ 135v               |

For many locations, the normal open circuit voltage (based on the PV panel's spec sheet value at 25 °C / 77 °F) of the overall PV array should be keep under 125v DC in normal conditions. This allows the PV array voltage to rise up to 25v more without exceeding the maximum safe level for the MX60 controller.

If the location of the system is in a very cold area - then wiring the panel in a “six in series” configuration of 12v nominal panels or “three in series” configuration of 24v nominal panels may not be a wise choice, as the voltage during very cold conditions may exceed the maximum 150v DC level.

In warm locations (Baja / Hawaii) the open circuit voltage of the PV array can be much closer to the 135v DC limit since the temperatures do not ever get very low.

In some locations the PV array's open circuit voltage may exceed the 135v DC level on a few rare occasions but not ever exceed the maximum voltage of 150v DC. Under these conditions the MX60 controller would suspend operation, resulting in a slight loss of power production. Since the coldest temperatures are usually encountered under very extreme conditions and in the early morning hours, very little power would actually be lost on an annual basis.

If you are unsure of the location's minimum expected temperatures, then it is recommended that the array be wired in a 48v DC or 60v DC nominal configuration only to prevent possible failure of the MX60 controller.

## INSTALLATION

The MX60 is designed to be mounted in a variety of ways. One of the more common methods of mounting is on an OutBack charge controller bracket (CCB), attached to an OutBack PSDC or a PS2DC enclosure. There is also a mounting tab at the top of the MX60. When mounted to the OutBack CCB, the left side knockout will line up with knockouts in the PSDC. A standard 3/4" or 1" plastic snap-in bushing will offer protection from chafing between the two boxes. Note that there are two placement options on the CCB that can be used to match with knockouts on the PSDC. Mounting holes and knockouts are compatible with C40 controllers to help set an industry standard. Two MX60 controllers may be installed on the CCB. Note the placement shown in Figure 1.



Figure 1. Two MX60 controllers on a Charge Controller Bracket with four FX2000, the PSDC and PSAC disconnect enclosures

## MOUNTING THE MX60

Up to three MX60's can also be mounted on the top of an OutBack PSDC disconnect enclosure. The MX60 will mount using 1" TSC threaded nipples to the locations shown below. Two MX60 controllers can also be mounted on the side of the PSDC enclosure using the optional OutBack CCB.



Figure 2. Three MX60 mounting options on the top of an OutBack PSDC Disconnect Enclosure

A standard 1" TSC threaded nipple may be used to secure the controller to the PSDC top for many installations. All of the wires will fit through one knockout so the other can be used as a means of attachment. If one knockout is used for wiring, then drill through and bolt the MX60 to the PSDC top using a #10 (5mm) bolt, lock washers and nut. The use of a 7/8 inch spacer behind the MX60 when installed in either of the two rear positions will allow the mounting foot holes to be used to secure the chassis back to the wall.

When mounting the MX in a confined space, be careful not to block the fan opening or the air inlet holes towards the bottom of the chassis on either side. However, one side may be blocked, but not both. Although this will not damage the controller, it will decrease efficiency and may cause it to shut off due to an over-temperature error.

## WIRE AND DISCONNECT SIZING

When wiring the MX60 note that there is a current limit on the output at 60 amps (default) and that the unit is listed to operate continuously at 60 amps. There is no 80% derating as required by the NEC for fuses, conductors, and most circuit breakers.

The MX60 is a buck type converter and cannot boost the output current when the PV array peak power point voltage is at or below the battery voltage as may happen on hot days in 24VDC PV and a 24VDC battery system or a 48VDC PV and a 48VDC battery system.

This unit can supply up to 60 amps output depending on the nominal PV array voltage and the nominal battery voltage. The output is current limited to 60 amps. To meet minimum NEC requirements, the output conductor should have an ampacity after any temperature and conduit fill corrections of  $1.25 \times 60 = 75$  amps (NEC 310.15, 690.8, 9). This would normally indicate that the output conductors would be 4 AWG, but a larger size may be required if there are temperature and/or conduit fill corrections required. With an output conductor rated at 75 amps (1.25 times continuous output current), a circuit breaker rated for continuous 100% duty at 60 amps (continuous output) like the OutBack OBDC-60 breaker may be used to provide the code-required disconnect and output circuit over current protection.

The PV array output connected to the MX60 input may be as high 60 amps, but at this current level, there is very little (if any) current boosting or maximum power-point tracking due to the 60-amp output current limit. Additionally, the input current may exceed 60 amps on bright sunny days and any excess power would be lost. The size and ampacity of the input conductors must be selected to handle 1.56 times the short-circuit current of the PV array. Any disconnect or circuit breaker connected to the input conductors must also be rated at 1.56\* times the short-circuit current for the PV array unless the breaker is rated for 100% duty in its enclosure. If that is the case, the circuit breaker may be rated at 1.25 times the PV array short-circuit current. OutBack OBDC-XX breakers are 100% duty rated breakers.

In terms of NEC compliance and the 60-amp output rating on the MX60, the largest PV array that can be connected to the MX60 should have a rated short-circuit current of 48 amps. This will meet NEC requirements and allow the MX60 to perform maximum power-point tracking functions. The following charts show maximum distance in feet of various gauge two conductor copper wire from the PV array to the MX60 MPPT PV charge controller with a 1.5% maximum voltage drop. Temperature and conduit fill corrections may be required.

Below is a list of recommended array sizing\* for the MX60 charge controller for various nominal voltage batteries:

\*Please reference APPENDIX F for additional information on array sizing guide

| <b>Nominal Battery Voltage</b> | <b>Recommended Array Size (in watts)</b> |
|--------------------------------|--|
| 12v                            | 800w                                     |
| 24v                            | 1600w                                    |
| 36v                            | 2400w                                    |
| 48v                            | 3200w                                    |
| 60v                            | 4000w                                    |

UL requires  $I_{sc}$  to be multiplied by 125% for the conductor rating  
\*NEC requires  $I_{sc}$  to be multiplied by 125% (after UL calculations) for conductor rating

## WIRE DISTANCE CHART

The following chart show a maximum distance in feet of various two conductor copper wire from the PV array to the MX60 PV MPPT charge controller with a 1.5% maximum voltage drop. Using a higher voltage PV array with a low voltage battery system allows you to use a much smaller wire size or go up to 5 times as far with the same gauge wire.

### WIRE GAUGE

**12 Volt PV Array**  
 12 16V MPP Typical  
 Distance in Feet (Two Wires)  
 1.5% Voltage Drop  
 12 Volt Battery System

| Amps | #8 | #6 | #4 | #2 | #1/0 | #2/0 | #4/0 |
|------|----|----|----|----|------|------|------|
| 8    | 22 | 35 | 57 | 90 | 145  | 180  | 290  |
| 10   | 18 | 28 | 45 | 72 | 115  | 145  | 230  |
| 15   | 12 | 19 | 30 | 48 | 76   | 96   | 150  |
| 20   | 9  | 14 | 22 | 36 | 57   | 72   | 116  |
| 30   | 6  | 9  | 15 | 24 | 38   | 48   | 77   |
| 40   | 4  | 7  | 11 | 18 | 29   | 36   | 56   |
| 50   | 3  | 5  | 9  | 14 | 23   | 29   | 46   |
| 60   | 3  | 4  | 7  | 12 | 19   | 24   | 38   |

**24 Volt PV Array**  
 32V MPP Typical  
 Distance in Feet (Two Wires)  
 1.5% Voltage Drop  
 12 or 24 Volt Battery System

| Amps | #8 | #6 | #4  | #2  | #1/0 | #2/0 | #4/0 |
|------|----|----|-----|-----|------|------|------|
| 8    | 45 | 71 | 114 | 180 | 290  | 360  | 580  |
| 10   | 36 | 57 | 91  | 145 | 230  | 290  | 460  |
| 15   | 24 | 38 | 60  | 96  | 153  | 192  | 300  |
| 20   | 18 | 29 | 45  | 72  | 115  | 145  | 232  |
| 30   | 12 | 19 | 30  | 48  | 77   | 97   | 154  |
| 40   | 9  | 14 | 23  | 36  | 58   | 72   | 112  |
| 50   | 7  | 11 | 18  | 29  | 46   | 58   | 86   |
| 60   | 6  | 9  | 15  | 24  | 38   | 48   | 77   |

**48 Volt PV Array**  
 64V MPP Typical  
 Distance in Feet (Two Wires)  
 1.5% Voltage Drop  
 12, 24 or 48 Volt Battery System

| Amps | #8 | #6  | #4  | #2  | #1/0 | #2/0 | #4/0 |
|------|----|-----|-----|-----|------|------|------|
| 8    | 90 | 142 | 228 | 360 | 580  | 720  | 1160 |
| 10   | 72 | 114 | 182 | 290 | 460  | 580  | 920  |
| 15   | 48 | 76  | 120 | 192 | 306  | 384  | 600  |
| 20   | 36 | 58  | 90  | 144 | 230  | 290  | 464  |
| 30   | 24 | 38  | 60  | 96  | 154  | 194  | 308  |
| 40   | 18 | 28  | 46  | 72  | 116  | 144  | 224  |
| 50   | 14 | 22  | 36  | 58  | 92   | 116  | 172  |
| 60   | 12 | 19  | 30  | 48  | 77   | 97   | 154  |

**60 Volt PV Array**  
 80V MPP Typical  
 Distance in Feet (Two Wires)  
 1.5% Voltage Drop  
 12, 24 or 48 Volt Battery System

| Amps | #8   | #6  | #4  | #2  | #1/0 | #2/0 | #4/0 |
|------|------|-----|-----|-----|------|------|------|
| 8    | 112  | 177 | 285 | 450 | 725  | 900  | 1450 |
| 10   | 90   | 142 | 227 | 362 | 575  | 725  | 1150 |
| 15   | 60   | 95  | 150 | 240 | 382  | 480  | 750  |
| 20   | 45   | 72  | 112 | 180 | 287  | 362  | 580  |
| 30   | 30   | 47  | 75  | 120 | 192  | 230  | 385  |
| 40   | 22.5 | 35  | 57  | 90  | 145  | 180  | 280  |
| 50   | 17.5 | 27  | 45  | 72  | 115  | 145  | 215  |
| 60   | 15   | 23  | 37  | 60  | 96   | 121  | 192  |

**72 Volt PV Array**  
 96V MPP Typical  
 Distance in Feet (Two Wires)  
 1.5% Voltage Drop  
 12, 24 or 48 Volt Battery System

| Amps | #8  | #6  | #4  | #2  | #1/0 | #2/0 | #4/0 |
|------|-----|-----|-----|-----|------|------|------|
| 8    | 140 | 221 | 356 | 562 | 906  | 1125 | 1812 |
| 10   | 113 | 178 | 284 | 453 | 719  | 906  | 1437 |
| 15   | 75  | 119 | 188 | 300 | 478  | 600  | 937  |
| 20   | 56  | 90  | 140 | 225 | 359  | 452  | 725  |
| 30   | 37  | 59  | 94  | 150 | 240  | 287  | 481  |
| 40   | 28  | 44  | 71  | 112 | 181  | 225  | 350  |
| 50   | 22  | 34  | 56  | 90  | 144  | 181  | 269  |
| 60   | 19  | 29  | 46  | 75  | 120  | 151  | 240  |

## SURGE PROTECTION

Since PV arrays are usually mounted on a roof or other elevated structure, protection from lightning induced surges and other transient power disturbances between the PV array and the MX60 charge controller is highly recommended. A surge protection device on the input side (PV+) of the MX60 is recommended, and on dwelling roof-mounted arrays an Outback OBDC GFP/2\* is highly recommended. If the connection from the MX60 to the battery string is over 15 feet or if it is routed adjacent to other wiring or sources of power, surge protection on the battery side of the MX60 is also recommended. **Surge protection is required for extended warranty coverage.**

\* Please reference APPENDIX A for the OBDC GFP/2 Installation

## FIELD WIRING CONNECTIONS

The wiring terminal for the MX60 charge controller is shown in Figure 3. There is no required connection sequence. **NOTE: Each MX60 will need its own PV array. DO NOT parallel MX60 PV + and PV - terminals.**



Figure 3. MX60 wiring area and wiring terminals

The 4 Position terminal block in the center is for, (left to right) PV+, PV-, BAT- and BAT+. The PV- and BAT- terminals are connected internally so one negative wire may be all that is necessary to run back to the main system negative bus bar. The aluminum ground lug on the right side is the chassis/equipment ground. The equipment ground terminal can be mounted on the outside of the enclosure if desired, although normally the equipment-grounding conductors will be routed in the same conduits with the input and output circuit conductors. If the equipment ground terminal is placed on the outside, make sure that the star washer is re-used. This washer is used to penetrate through the paint, thus grounding the chassis. The NEC requires the use of a PV array disconnect and a battery disconnect. The MX60 can use a 60 amp 125VDC breaker such as the OBDC60 breaker.

All of the large terminals should be torqued to **30 inch-pounds**. The PV/BAT terminal block and chassis/equipment ground terminal will accept up to 2AWG wire. An optional OutBack battery temperature sensor also known as a Remote Temperature Sensor (RTS) can be connected via the RJ11 “phone” type jack marked “Battery Temp” to the right of the BAT+ terminal. This sensor is mounted on one of the batteries using the double-back tape. Battery manufacturer recommended charging regulation voltages are based on 77°F / 25°C temperature conditions. Your batteries will not be properly charged using the manufacturer’s charging regulation set points without a RTS unless the batteries remain at 77°F / 25°C. The OutBack RTS will automatically increment or decrement the set point-

voltages charger depending on the battery's temperature. This is especially important in very cold or very hot climates. **The RTS is a highly recommended option.**

With the MATE and HUB, only one RTS is needed for multiple FX inverters and/or MX60s. The master FX or MX, plugged into port one of the HUB, reads the RTS value and distributes the information to the other units. If the system contains a single FX, then the FX needs to be the master and have the RTS plugged into it. If using a combination of FXs and MXs, the master FX inverter must be connected to port one of the HUB.

To the right of the battery temperature sense jack is a small two position terminal block marked AUX. The terminals are marked (-)12v (+). The terminals are programmable to accomplish an assortment of functions such as load diversion or alarms. The max current available from this terminal block is **200 milliamps**. This is sufficient to power a coil of a small relay, Piezo-buzzer, or LED indicator. However, this may not directly drive a Mercury Displacement Relay (MDR) because of their high turn-on surge requirement, but a smaller external relay may be used to indirectly operate bigger relay or contactor coils. The Aux output can be programmed to be Active High or Active Low for all of the Aux output functions.

To the left of the PV+ terminal is an RJ45 jack marked MATE. The OutBack MATE (or HUB) would be plugged in to this jack. The MATE can be used to remotely display the MX60 status and to trigger multiple MX60s for certain functions such as Equalization.

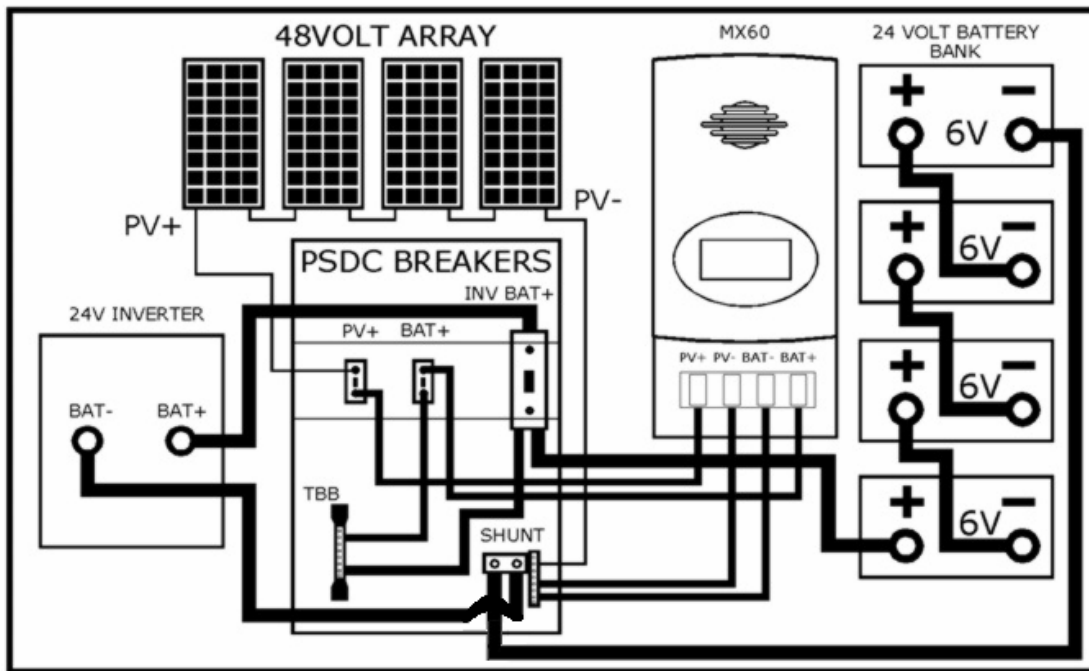

Figure 4. The OutBack MX60 with PSDC Enclosure

Note: Please reference APPENDIX B for wiring diagram with factory installed parts and options

## SYSTEM CONFIGURATION

### YOU MUST SELECT THE BATTERY SYSTEM VOLTAGE FIRST!

#### Battery System Voltage

The nominal battery system voltage can be changed from the default 12 volt battery settings to match your particular battery system. Only the battery system voltage needs to be set. The MX60 **automatically** detects the PV array voltage and finds the maximum power point during operation.

Setting the nominal battery system voltage will require entering a password to change any parameter. The following password is required for this unit: **141**. Use the following procedure to change parameters:

1. Start with the PV and Battery breaker turned off
2. Hold down soft key buttons **1** and **3**. (From left to right the buttons are **1, 2, 3** and **4**)
3. Turn battery breaker / disconnect on while holding soft keys **1** and **3** down simultaneously.
4. Release both soft keys once the “OutBack Power Systems” is displayed on the LCD screen.
5. You will now be at the voltage selection screen. Pressing **→** or **ENTER** will require the password.
6. Push - (minus) until the number reaches **141**. Press the soft key below the word “**ENTER**”.
7. Press the soft key below “**NEXT**” to select the nominal battery voltage of your system, then press “**ENTER**”. The MX60 will prompt “**ARE YOU SURE?**” When you push the “**YES**” soft key, the unit will reset, then display the sign-on screen (with system voltage in the upper-right corner) and Status screen

#### Resetting to Factory Default

To reset these parameters to the factory defaults, repeat steps 1 through 7 above. The charger regulation Absorb and Float voltages will be modified automatically with the use of the external temperature sensor. You can view the compensated voltages in the **misc** Screen. The compensation provided is -30 millivolts per degree C for a 12 VDC system. This amount is automatically doubled for a 24 VDC system, quadrupled for a 48 VDC system, etc. If after entering the system voltage setup screen you press **EXIT**, or just let it sit in this screen for 5 minutes without pressing any buttons, the MX60 will automatically start operating at the previous system voltage setting. The user can change many MX60 factory default parameter settings. Disconnecting the MX60 from the battery will not require re-programming.



Setting system Voltage with the “Mind Meld”

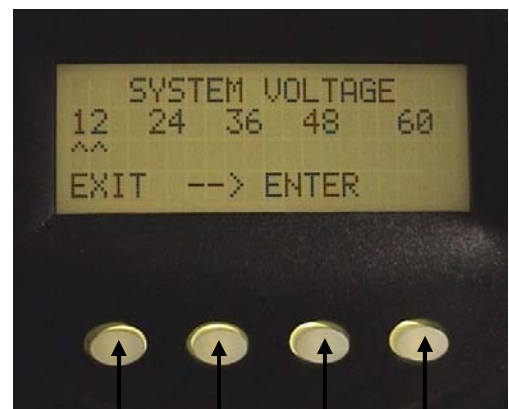

Soft Keys 1 2 3 4

## POWER UP SCREEN

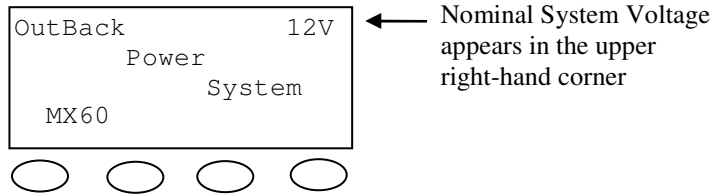

Figure 5 - MX60 Power Up / Start-up screen

## STATUS SCREEN

The MX60 Charge Controller has a 4 line, 80 character LCD display and four “soft key” buttons to allow the user to adjust battery charging parameters and access other information. Figure 6 shows the Status screen. This screen shows the following information:

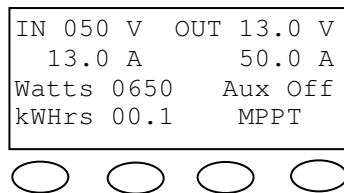

Figure 6. Status Screen

The displayed information is defined as follows:

|   |  |
|---|--|
| <b>IN 050V</b> = PV Input voltage             | <b>OUT 13.0V</b> = Battery voltage             |
| 13.0A = Input PV current                      | 50.0A = Output current (to battery)            |
| <b>Watts 0650</b> = Instantaneous watts       | <b>Aux Off</b> = Programmable Auxiliary Output |
| <b>kWHrs 00.1</b> = KiloWattHours accumulated | <b>MPPT</b> = Operational Mode *               |

\* Please reference APENDIX D for more information on the various Operational Modes

Pressing soft key **1** directs you to the Main Menu screen, and holding button **2** toggles the MX60 between **Amp Hours** and **kW Hours** display mode as shown in Figures 6.1 and 6.2 below. Pressing buttons **3** and **4** simultaneously (for a moment) in MPPT mode will usually force a mini-sweep of the PV input.

Figure 6.1. Status Screen with kWHrs display

Figure 6.2. Status Screen with AmpHr display

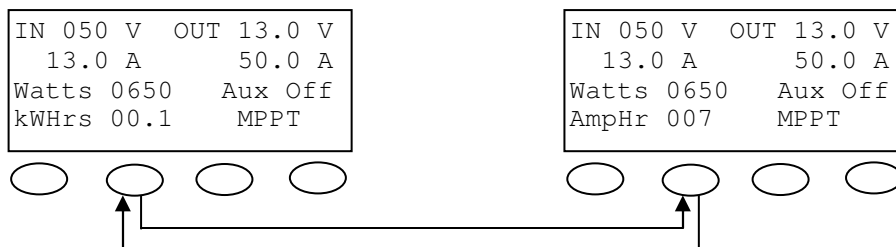

## MAIN MENU

Press ← or → to align the asterisk \* in front of the desired screen

|          |      |          |    |
|----------|------|----------|----|
| *charger | aux  | light    |    |
| eq       | misc | optimize |    |
| logging  | log2 |          |    |
| EXIT     | ←    | →        | GO |

○
○
○
○

Press “GO” to take you to the highlighted screen. EXIT returns to the Status screen

Figure 7. Main Menu Screen

To arrive at the Main Menu screen, press soft key 1 in the Status screen. You will see the screen of selectable menus as shown in Figure 7 above. From here, press “←” or “→” to align the asterisk in front of the selected menu choice, then press GO. From the menu option you selected, pressing EXIT from that screen will direct you to the Status screen and save any data that was changed into non-volatile memory. Pressing EXIT from the Main Menu screen will direct you back to the Statue screen again.

## CHARGER SETUP

Pressing “→” selects which parameter you are going to Increase or Decrease

|       | LIMIT | ABSORB | FLOAT |
|-------|-------|--------|-------|
|       | Amps  | Volts  | Volts |
| *60.0 | 14.4  | 13.6   |       |
| EXIT  | →     | -      | +     |

○
○
○
○

Press “EXIT” to save the new settings & return to the Status Screen

Figure 8. Charger Setup Screen

The charger parameters are automatically set to appropriate defaults when the nominal battery system voltage is set, and is user selectable. The default charging regulation “ABSORB” and “FLOAT” voltage set points are based on a typical lead acid battery system\*. The default charger current limit is 60 Amps and can be changed for circuit breaker or wire size limitations and is adjustable up to 70 Amps for those of you that actually read this manual. The words “Absorb Volts”, “Bulk Volts”, or, “Bulk *termination* Volts” are synonymous here. The Bulk cycle reaches the Absorb charging regulation voltage set point and continues the Absorb stage (ABSORBING) at that voltage. If the battery manufacturer recommends a different ABSORB and FLOAT charging regulation voltage set points, you can adjust the set points using the **charger** set-up screen shown in Figure 8. The actual target voltages will be different if a battery temperature sensor is installed, and those values can be viewed in the Miscellaneous (**misc**) screen under the Tmp Comp heading. Pressing “→” selects the parameter to be changed. The presently selected parameter will have an asterisk “\*” to the left of it. You *may* need to re-enter the password to change these settings.

\*Please reference APPENDIX 3 for suggested battery charger regulation set points

## AUX OUTPUT CONTROL

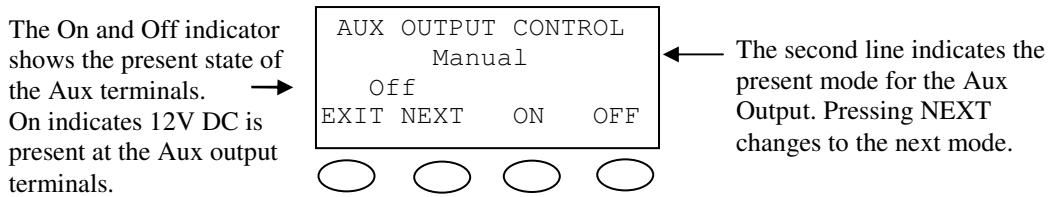

Figure 9. Aux Output Setup Screen

### Aux Output Control -- Explained

The user can set the function for this secondary control circuit. The choices are: Manual, Vent Fan, PV Trigger, Night Light, Float stage or Current into the battery, Error Alarm, Diversion, Low Battery Disconnect, and Remote. The terminals marked "AUX", supply a 12 VDC (nominal) at 200 milliamp max output current to drive a small relay coil, 12V LED indicator, Piezo buzzer, or a solid state relay.

**When an Aux Output option is selected simply exit the menu to initiate the selected Aux Output option.**

Example: Aux Output Control → VentFan→Adjust set point→Vent Fan→ Exit to Status screen.

### Manual

Activates or Deactivates the Aux output manually using the MX60 soft key. Press ON or OFF to activate or deactivate the Aux output.

### Vent Fan

The Aux output becomes active when the battery voltage exceeds the Vent Fan voltage setting. This mode is useful for controlling a fan for venting hydrogen out of a battery room, or triggering an over-voltage alarm. The Aux output will stay active for a *minimum* of 30 seconds after the Vent Fan voltage is exceeded.

### PV Trigger

Activates the Aux output when the PV input exceeds the voltage set point for a minimum adjustable amount of "Hold time". This might be useful for sounding an alarm if the MX60 input terminals go beyond a certain voltage.

Figure 10 shows the main PV trigger Aux screen.

**VOLT** adjusts the PV input voltage, above which the output will go Active. Adjustable from 20 to 140 Volts

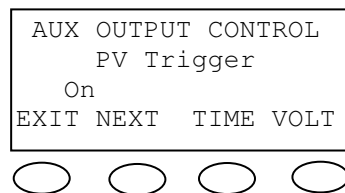

**TIME** adjusts the minimum Aux output **HOLD time** from 0 to 25 Seconds

Figure 10. PV Trigger Main screen

The maximum input voltage for an MX60 should **not** exceed 150 Volts, which can happen if a 72-volt nominal array is used, in sub-zero temperatures. Do not use it to operate a diversion load across the PV terminals, however, this mode *could* be used to operate a series latching relay that disconnects the PV array if the voltage goes higher than the voltage set point. Watch for a future active voltage clamp/diversion product that keeps input voltages from going beyond a set ceiling voltage. Micro-Hydro and wind will then be better suited to take advantage of the MX60s current boost technology. As it is now, you must be sure the input will not exceed the MX60 input ratings. Many are already using the MX60 with Micro-Hydro as a series controller.

### Night Light

Night Light mode activates the Aux output at “Night”. “Night” occurs after 7 minutes of **Sleeping** and deactivates the Aux output at the next MX60 Wakeup.

### Float or Output Current

This mode may be used to enable a load, if and only if, the MX60 is producing power or if the MX60 is in the float stage. An example may be to turn on a water pump. The Aux output will not go active until the output current is at or above the **Max** current. The Aux output will be inactive when the current falls below the **Min** current. If both Min and Max Amps are 00, then the Aux output will go active whenever the MX60 is in the Float stage.

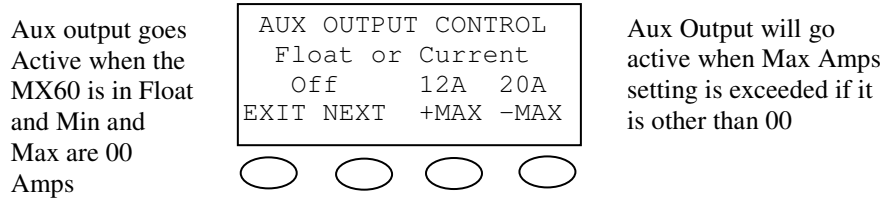

Figure 11. Float or Current output trigger

### Error Alarm

The default state is “On” (12 v). If the MX60 charge controller has not charged the batteries for 26 hours or more continuously, the Error Alarm will switch to the “Off” state (0v). The MATE will display “Disabled” in its Aux Output mode menu if the Error Alarm option is selected. *Note: This is NOT an internal audible alarm!*

### Diversion

Used when a wind or hydro generator is connected directly to the batteries and excess power needs to be diverted away when the battery is full. The AUX output terminals will become active when the battery voltage reaches the ABSORB or FLOAT voltage relative to a user adjustable value. The value is adjustable in tenths of a volt from -5.0 volts to 5.0 volts relative to the ABSORB or FLOAT set point (temperature compensated Absorb or Float voltage set point if the OutBack BTS is installed). A Hysteresis (HYST) adjustment controls when the Aux output will go inactive again, after the battery voltage falls below the relative voltage *minus* the HYST voltage value. The HOLD time determines the *minimum* time the output stays active after the battery voltage falls below the hysteresis voltage.

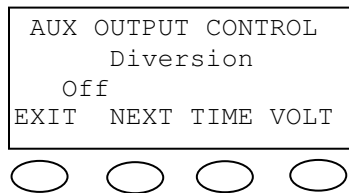

Figure 12. Aux Diversion main menu

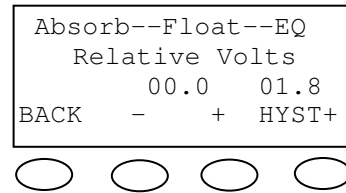

Figure 13. Diversion VOLT setup screen

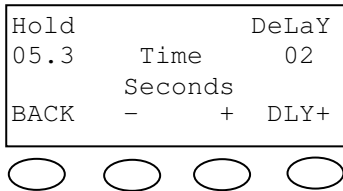

Figure 14. Diversion TIME setup screen

### Diversion Volt

The “+” and “-” buttons adjust the trip point voltage *relative* to the Absorb or Float set point voltage necessary to activate the Aux output terminals. For example, if the MX60 was in the Float charge stage, and the battery voltage rises above the Float voltage, *plus* this relative voltage, (*minus* this voltage if its polarity is -), the Aux output terminals would go active as long as the battery voltage stays there for at least the **DELAY** time. If HYSTeresis is set to a value other than zero, then the battery voltage must fall to the *relative* voltage *minus* the HYST voltage value, and stay below the *relative* voltage minus the HYST voltage before the Aux output will deactivate. For example, if the Float voltage, (temperature compensated), is 13.6 Volts, HYST is 1.8 volts, as shown in Figure 13, and the Aux output was active due to the battery voltage going above the trip point longer than the delay time, the Aux output will go inactive when the battery voltage goes below 13.6 minus 1.8 volts, or below 11.8 Volts. The Aux output will not de-activate until the HOLD time is reached.

### Diversion Time

The **DELAY** time (**DLY**) *before* the Aux output activates (after going above the relative voltage) is adjustable from 0 to 24 seconds in 1 second intervals. Pressing **DLY+** will increment the Delay time and wrap around to zero after reaching 24. The **HOLD** time, (adjustable from 0.1 to 25.0 seconds), dictates how long the Aux output will stay active *after* the battery voltage has fallen below the hysteresis (**HYST**) set point. Pressing + increments this time and - decrements towards zero seconds.

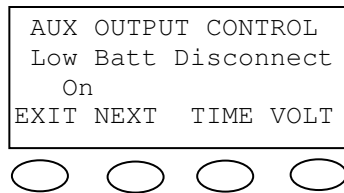

Figure 15. Low Battery Disconnect main screen

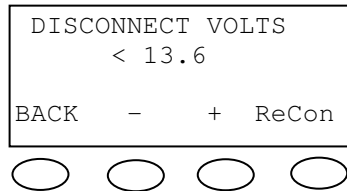

Figure 16. Low Battery Disconnect Volt setup

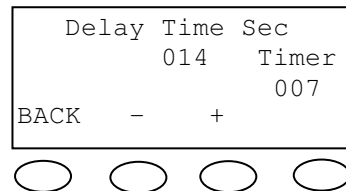

Figure 17. Low Battery Disconnect delay time

### Low Battery Disconnect

The Aux output terminals activate when the battery voltage falls below the low battery voltage set point for an adjustable delay time, and deactivate when the battery voltage exceeds the reconnect voltage set point after the same amount of delay time. The time delay is adjustable from 0 to 250 seconds.

### LBD Disconnect/Reconnect Voltage

Figure 16 shows the Low Battery Disconnect VOLT setup screen. Pressing soft key 4 will toggle between the Reconnect (ReCon) screen and the Disconnect (DisV) voltage menus. In this example, the Aux output will go active when the battery voltage goes *below* 13.6 volts for 14 seconds, and it will de-activate when the battery voltage goes *above* the ReCon Voltage set point, after the timer has counted back to zero.

The LBD Disconnect/Reconnect screen is also used to set the Upper and Lower battery temperature compensated voltage range limits. See the **misc** section.

### LBD Delay Time

Figure 17 shows the Delay Timer setup screen. Assuming that the Aux output was *inactive*, because the battery voltage was above the ReCon voltage, when the battery voltage falls below the DisV voltage set point, the -

Delay Timer will count up to the delay time set point (in seconds), and as soon as that time is reached, the Aux-output will go active. When the battery voltage rises above the ReCon voltage set point, the Delay Timer will count down again, towards zero, and when it reaches zero, the Aux output will go inactive, turning the load back on again. Note: If, instead, you would rather that the Aux output produces zero (0) volts when you want the loads to disconnect, and 12 volts when they are connected, the Optimization setup menu will allow you to reverse this relationship by changing the Aux output from Active High to Active Low.

**Remote**

An OutBack MATE can control the operation of the Aux output of the MX60 controller if Remote mode is selected.

## BACKLIGHT CONTROL

The backlighting of the LCD screen and the buttons consumes about 3/4 watt. The user can control backlight options using the setup screen shown in Figure 18. Depending on your energy production, you may elect to leave the backlight off or on. There is also a third option labeled Auto (default). The initial tapping of any soft key while in Auto mode will turn the Backlight lights on for 60 seconds. This initial tap to turn on the Backlight will not change any settings.

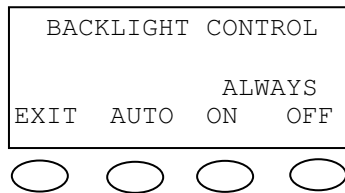

Figure 18. Backlight Control Set-up Screen

## EQ -- BATTERY EQUALIZE

Flooded electrolyte batteries should occasionally be subjected to an equalization cycle to convert sulfation from the lead plates. This process can be **dangerous**, so make sure you understand it completely before equalizing your batteries! The screens shown in Figures 19 through 21 allow the user to change the equalization voltage set point and time limit as well as Start or Stop the equalization cycle. The EQ voltage and time is also used when a global equalization is triggered remotely. The DC loads should be turned off and the battery should be charged enough so that the MX60 can reach the EQ set point voltage.

**NOTE: VALVE REGULATED LEAD ACID (VLRA) OR OTHER SEALED TYPE BATTERIES SHOULD NOT BE EQUALIZED UNLESS SPECIFICALLY RECOMMENDED BY THE BATTERY MANUFACTURER**

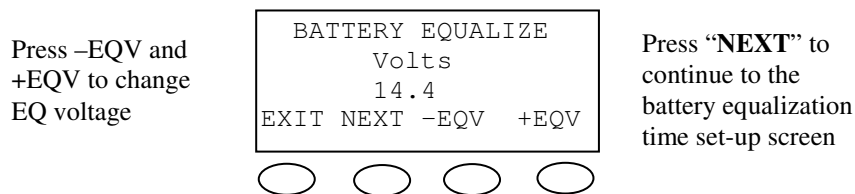

Figure 19. Battery Equalization Voltage Set-up Screen

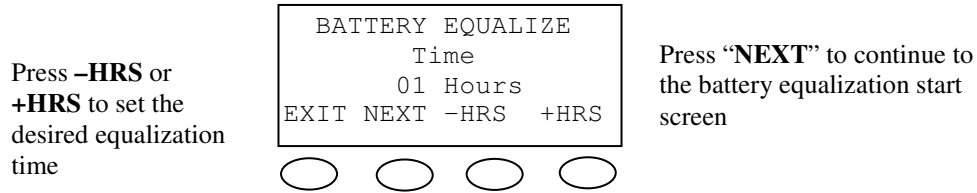

Figure 20. Battery Equalization Time Set-up Screen

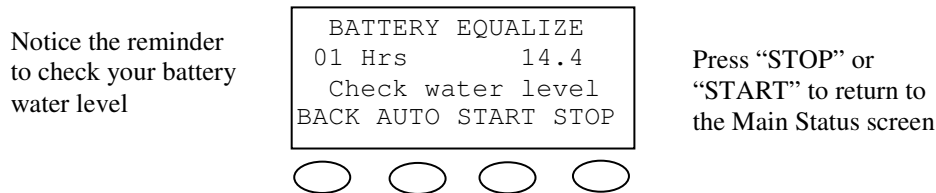

Figure 21. Battery Equalization Start Screen

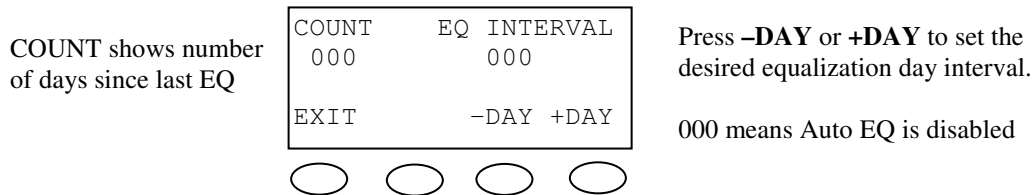

Figure 22. Auto Equalize Equalization Start Screen

**Manual Equalization Cycle**

The Battery equalization charge cycle can be started manually, either from the MX60 or from a compatible MATE/FX and hub network system. The screen shown in Figure 21 is used to start a manual equalization charge cycle. The EQ cycle is automatically terminated when the EQ time period is reached. After an equalize charge cycle has terminated, an **"EQ DONE"** message is displayed, and a Float charge state begins.

When an EQ charge cycle is initiated, **"EQ MPPT"** is displayed indicating that the MX60 is trying to reach the target equalize set point. Upon reaching the equalize set point the elapsed equalize time **"EQ 0:00"** in Hours:Minutes is displayed. If an equalization cycle has been initiated, but not completed on the same day, it will be continued into the next day. However, an equalization cycle that is not completed on the same day it is initiated *will not* continue onto the next day if the MX60 is powered off or manually stopped.

**Auto Equalization Cycle**

An auto equalization cycle will be initiated when a preset interval day is reached. An interval day from 1day up to 250 days can be selected (See Figure 22). The default equalize interval (**EQ INTERVAL**) setting is 000 day, hence auto equalize is disabled. The equalize interval is set by incrementing or decrementing the **-DAY** or **+DAY** for a desired time interval. Example, if the **EQ INTERVAL** is set to initiate every 90 days, and 30 days has elapsed since the initial setup or since the last auto equalize cycle, the **COUNT** will display 30.

When an auto equalize cycle starts, as in the manual equalize, **"EQ MPPT"** is displayed indicating that the MX60 is trying to reach the target equalize set point. The equalize time in Hours:Minutes **"EQ 0:00"** will be displayed when the equalize set point is reached. If an auto equalize cycle has been initiated, but not completed on the same day, it will be continued into the next day. The **COUNT** value will be cleared to 000 when an EQ is started, manually stopped, or when the MX60 has been powered off.

## MISC -- MISCELLANEOUS

### Miscellaneous Screen -- Explained

The screens shown in Figures 23, 24 and 25 are for extra settings and technical information. Service calls to OutBack may require reporting some of these values for troubleshooting purposes. The following is a brief description of the contents of this screen:

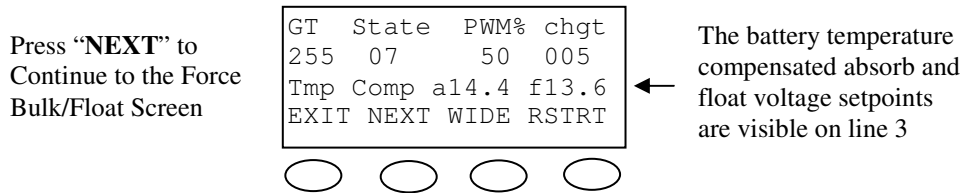

Figure 23. Miscellaneous Screen 1

|                    |  |
|--------------------|--|
| <b>GT (X)</b>      | GridTie value sent from the FX inverter through the MATE for GridTie control communications. An "X" means that an FX is in GridTie mode and is sending information to the MX60. (See Optimization menu/MPPT MODE---non-GT/FX-GT)   |
| <b>State</b>       | The MX60 has thousands of lines of code. Each MPPT operation is called a state. This number is useful for troubleshooting and may be asked for when calling the factory.   |
| <b>PWM%</b>        | The duty cycle of the buck converter. At 50%, the PV terminals would be twice battery voltage.   |
| <b>ChgT</b>        | The minute counter for the Absorption cycle. It counts up from the minimum Absorb time, normally 000, while in the Bulk cycle, and then counts down (in minutes) from a maximum Absorption cycle time. This allows the MX60 to enter the Float stage sooner when the controller starts the charging cycle with a full battery. The Absorb stage can sometimes be abbreviated and end sooner by setting the Absorb ending Amps to a value other than 00 Amps. (See the MISC 3 screen) |
| <b>Tmp Comp</b>    | Battery temperature compensated Absorb and Float set points. The set points will rise when the battery is cold and will be reduced when the battery is hot. If no external battery temperature sensor is available these settings will equal those found in the <b>charger</b> setting screen.   |
| <b>WIDE / LMIT</b> | <b>WIDE</b> (default) covers the normal battery temperature compensation voltage range.<br><b>LMIT</b> mode limits the Upper and Lower battery temperature compensated voltage range.  |
| <b>RSTRT</b>       | Forces the MX60 to restart or wakeup from a 5 minute interval "Snoozing" mode.   |

### WIDE/LMIT Battery Temperature Compensated Limits

When using an Outback Remote Battery Temperature Sensor (BTS/RTS), the battery temperature compensated voltages (Absorb and Float) range can be wide. Some batteries have an absolute voltage limit that should not be exceeded, and by initiating the **WIDE/LMIT** option in the **misc** menu, the user has the ability to manage the upper and lower battery temperature compensated voltage (Absorb and Float) limits. The default RTS voltages are set for a typical lead acid batteries, and are only applicable, if and only if, the **WIDE/LMIT** feature in the **misc** menu is set to **LMIT**. The default battery temperature compensated values for the lower range is 13.2v and the upper range is 14.1v for a 12v system. The upper and lower settings can be viewed in the second menu of the LOG2 screen. These **LMIT** default values are for GNB Absolyte IIP batteries.

**Setting the Upper and Lower battery temperature compensated voltage range limits**

The lower and upper BTS voltage limits can be set in the **Low Battery Disconnect (LBD) DISCONNECT/RE-CONNECT** voltage menu. When in the **LBD** Aux menu, press the soft key under **VOLTS** to enter the **DISCONNECT VOLTS** menu. When in the **DISCONNECT VOLTS** menu, decrement or increment the desired **lower** battery compensated voltage by pressing the (-) or (+). When the desired voltage is reached, then simultaneously press (-) **and** (+) until “Lower Limit” is displayed. The **upper** battery compensated voltage can be adjusted by pressing **ReCon**. In the **RE-CONNECT VOLTS** menu, adjust the desired compensated voltage to the desired value, then press (-) **and** (+) simultaneously until “Upper Limit” is displayed, then press DisV or BACK to clear the display. When the words “Lower Limit” or “Upper Limit” are displayed, the desired compensated voltage has been stored, and the (-) and (+) buttons can be released (pressing **BACK** will only clear the “**Lower Limit**” and “**Upper Limit**” words). After setting these limits, **AUX OUTPUT CONTROL** should be set to **Manual** (default) if not used. To return to the desired **AUX Output Control** mode, simply select the desired Aux Output mode and exit the screen. The original **LBD DISCONNECT/RE-CONNECT** voltages will have changed by this procedure and should be readjusted if the **LBD AUX** mode is being used.

Note: Battery temperature compensated charging voltage (**WIDE/LMIT**) is not applicable in the Equalize charging mode

Please reference APPENDIX 2 for more information on Battery Temperature Compensated Voltage Set Points

**Force Bulk or Float**

Pressing the button under **FLOAT** or **BULK** will force the **MX60** into that charge state and return to the main Status screen. Forcing a **BULK** or **FLOAT** while Equalizing will stop the **EQ** charge cycle.

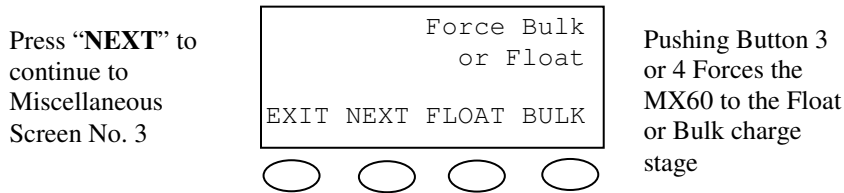

Figure 24. Miscellaneous Screen 2

### Miscellaneous Screen 3 -- Explained

ReBulk will re-initiate another daily bulk charge cycle if battery voltage falls below the set value for 90 seconds. Default of 6 Volts is disabled

|        |       |      |      |
|--------|-------|------|------|
| PCB    | Err   | Btmp | CFB  |
| 398    | 000   | 255  | 0688 |
| ReBulk | 06 V  | End  | 00 A |
| EXIT   | +ReBV | -AMP | +AMP |



Figure 25. Miscellaneous Screen 3

|  |  |
|--|--|
| <b>PCB</b>                                 | Temperature measurement value used to control the cooling fan's operation and to provide over temperature protection of the internal electronic components. This temperature measurement is not the actual internal temperature in degrees C or F but is an arbitrary number used for reference. The lower the number, the higher the temperature. 25 degrees C is approximately a value of 525.   |
| <b>Err</b>                                 | Error time counter, in hours, that increment hourly if the MX60 has not charged the batteries for 26 hours or more continuously. <i>Only applicable if the Error Alarm option is selected in the Auxiliary Output Control menu.</i>  |
| <b>Btmp</b>                                | Battery temperature sensor reference value used to compensate the charging voltage. This is an arbitrary number between 0 and 255 and is not the actual temperature in degrees C or F. An 'X' next to this value indicates a Global external BTS is being used (system with a HUB and MATE).   |
| <b>CFB</b>                                 | Output value of the internal current sensor used to calculate output amps, watts, and track the Maximum Power Point of the array.  |
| <b>ReBulk</b>                              | If the battery voltage falls below the ReBulk voltage set point for at least 90 seconds, the MX60 will reinitiate a Bulk charge cycle. The default is set to a very low value (6 volts) and therefore the function will be disabled.   |
| <b>+ReBV</b>                               | ReBV increments the ReBulk Voltage. It will wrap around to a low 6 volt value when a 69 volt value is reached.   |
| <b>End</b><br><b>-EndA</b><br><b>+EndA</b> | Normally an Absorb charge cycle is terminated because the battery voltage was regulated at the Absorb set point for the maximum time period. Decreasing ( <b>-AMP</b> ) or increasing ( <b>+AMP</b> ) sets an optional end current level in DC amps, displayed as the <b>End</b> number in amps. While the MX60 is regulating the charging process in the Absorb stage, and the End current level is reached before the charge timer has reached zero, (ChgT in Figure 22), the MX60 will switch to the Float charge stage. This is an optional set point and is not required to be adjusted in most installations. "00" Absorb End amps is the default. |

#### Absorb Ending Amps Adjustment (EndA)

One way for the MX60 to complete an Absorb cycle before the charge timer (ChgT) reaches zero, is for the Absorb ending Amps to be set to a value other than the default of "00" Amps (*see miscellaneous 3 screen*). If the Absorb ending amps setting is set to, for example, 12 amps, then, when the battery current dropped to 11.9 amps, the Absorb cycle would end, the charge timer would be reset to zero, and the MX60 would continue in the float stage. The next Bulk/Absorb cycle will not start until either, the next morning, a 24/25 hour period if the sun did not set, (*see LOG2 screen*), a **Force Bulk** being initiated, (*see miscellaneous 2 screen*), or, a **Re-Bulk** occurs because the battery voltage fell below the ReBulk voltage setting for 90 seconds (*see miscellaneous 3 screen*).

Some batteries reach the Absorb voltage very quickly... too quickly in fact, for the battery to get a good Bulk/Absorb cycle in. This is why you might want to change the minimum absorb time to something other than zero. The Charge timer would normally rack up some time in the wee twilight hours of the morning because the current is so low, but if the current rises too quickly, this is a good way to ensure a minimum time in the Absorb stage.

## OPTIMIZATION

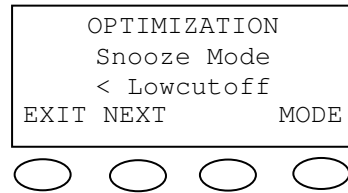

Figure 26. Lowcutoff Mode

### Snooze Mode

Very early or very late in the day, the resistance of the panels can be high. However, there may be enough open circuit panel voltage that the MX60 will want to wake up and operate when there is not really enough power to do any useful charging. Instead of waking and clicking and operating unnecessarily, the MX60 will try to “Snooze” for a few minutes and ignore this Voc. There are moments in the MX60s operation where the MX60 can look at the voltage rise time of the panels at the PV side capacitors and snooze if the panel voltage did not rise to the last measured panel Voc. After enough light is shining on the panels, the panel resistance goes down enough that the panel voltage rise time is fast and reaches the last Voc quickly so it will come up and operate and not snooze at that point. The MX60 will abort the Snooze cycle early if the Panel voltage goes a small amount above the last measured Voc. This is usually early in the morning when the Voc can be rising fairly quickly. Snoozing can also be initiated if the current into the battery did not reach the selectable cutoff current set point if in the **< Low cutoff** snooze mode.

|                       |  |
|-----------------------|--|
| <b>&lt; 90 % Voc</b>  | Snoozes if the panel voltage failed to rise to greater than 90 percent of the last measured Voc during a 1 second interval at the initial wakeup sweep, or at the <b>NewVoc</b> sampling in <b>U-Pick MPPT</b> mode. Typically, this <b>&lt; 90%</b> is preferred over the <b>&lt; 50%</b> mode. |
| <b>&lt; 50 % Voc</b>  | Snoozes if the panel voltage failed to rise to greater than 50 percent of the last measured Voc during a 1 second interval at the initial wakeup sweep, or at the <b>NewVoc</b> sampling in <b>U-Pick MPPT</b> mode.   |
| <b>&lt; Lowcutoff</b> | Snoozes if the initial sweep did not reach the Low Cutoff current. Useful in all modes but especially when the panel voltage is very close to the battery system voltage such as a 12 Volt battery and 12 volt array. This is the default snooze mode.   |
| <b>Disabled</b>       | No snoozing will occur. The MX60 may sleep and wakeup many times at dawn and dusk.   |

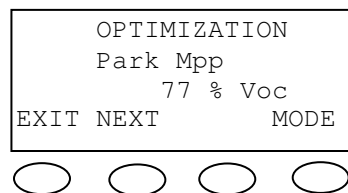

Figure 27. Park Mpp

### Park Mpp % (Voc)

Picks the PV panel working voltage for U-Pick MPPT mode and other conditions where the MX60 operates at a fixed percentage of the last measured open circuit voltage (Voc). This is not normally a critical exact value. A Maximum Power Point (MPP) of 77% of Voc is typically very close to the Maximum Power Point of most panels.

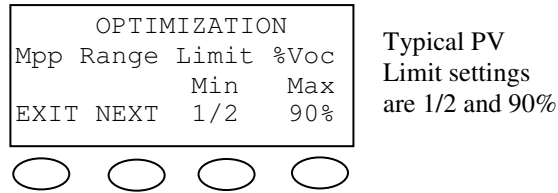

Figure 28. Mpp Range Limit adjustment

**Mpp Range Limit % Voc (Auto Sweep mode only)**

These settings adjust the upper and lower allowable Max Power Point limits of the input range (PV usually), and are expressed as a percentage of the Open Circuit voltage (Voc). A solar panel normally has a Maximum Power Point voltage *greater* than 1/2 of its Voc, but *less* than 90% of Voc. If a mini-sweep finds a Maximum Power Point voltage *greater* than the **MAX** voltage, or *less* than the **min** voltage, (**1/2** or **FUL**), the MX60 will revert to the **Park Mpp** instead (see Park Mpp % above). 90% Voc is the default maximum limit, 1/2 is the default minimum value and will not normally need to be changed. If the input PV Voc is greater than twice the battery voltage, setting the min range limit to 1/2 can speed up the initial wakeup sweep, because the input will not have to be “swept” down to the battery voltage as it would if it were set to FUL. For example, a 24 Volt battery and 72 Volt nominal PV array would only have to sweep from 120v down to 60v instead of to 24v.

The **MIN** range limit setting may set to **FUL** if something other than a PV array is connected to the input of the MX60, such as a Micro-Hydro generator, since these devices may have a Maximum Power Point voltage of less than 50% of their free-running voltage, but greater than the battery voltage. Remember, the input connected to the terminals of the MX60 **must not** present a voltage greater than the rating of the MX60 of **150v** at *any* time. And, the MX60 will get much hotter if the Maximum Power Point of the device is greater than about 114 volts, which would be the maximum voltage it would see with a PV array with a Voc of ~140 Volts. If the MPP voltage is greater than this, and the output current (into the battery) is near 60 or 70 amps, the MX60 may get too hot and shut down. The maximum adjustable MPP range limits are 80%, 85%, 90%, and 99% of Voc.

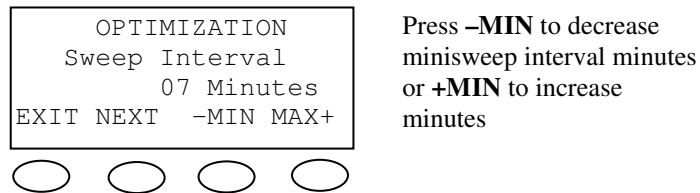

Figure 29. Mini Sweep Interval

**Sweep Interval**

Sweep Interval selects how often the MX60 does mini-sweep in Autosweep MPPT mode, or how often it acquires a New Voc in **U-pick** MPPT mode (see Optimization MPPT mode) to track the MPP of the array. When the operational mode display shows MPPT or EQ MPPT, and when the MX60 is configured for **AutoSweep** MPPT mode, the input source will be periodically swept, (at this sweep interval), up and down in voltage slightly to stay running at the Maximum Power Point operating voltage. How far it sweeps up and down depends upon the output (battery) current at that time. If the output current was less than 5 amps, but greater than the Low Cutoff current setting (see *Optimization Low cutoff*), then the MPP operating voltage will continue at the Park MPP (see *Optimization Park Mpp % Voc*). If a mini-sweep finds the MPP outside of the MPP range limit, the MX60 will run the PV input MPP at the selected Park % MPP setting. Adjustable from 0 minutes, (disable mini-sweep), to every 15 minutes.

Mini-sweeps are different than the initial wakeup sweep. The initial wakeup sweep will take the PV array input and “sweep” it down to either the battery voltage if minimum MPP range is set to **FUL**, or down to 1/2 of the Voc if set for **1/2** MPP range Limit. The initial wakeup sweep looks at the entire IV curve of the PV array input and sets the-

initial MPP operating point. The mini-sweep looks at a smaller portion of the IV curve starting at the initial MPP. The sweep and MPPT algorithm of the MX60 also works very well at finding the Max Power Point of partially shaded PV arrays, which is found in some systems.

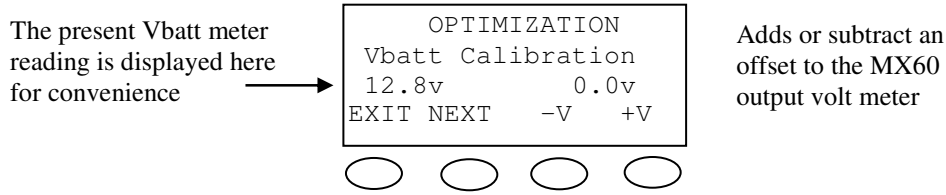

Figure 30. Vbatt Calibration Offset

**Vbatt Calibration (Output/Battery Voltage display Offset)**

Adjust the battery voltage reading and battery voltage feedback of the MX60. Adjustable between (+) ½ volt and (-) ½ volt, this setting is used to improve the accuracy of the MX60’s battery voltage readings. A good/calibrated voltmeter is required for in-field battery voltage calibration.

Please note that the MX60 voltage reading is taken near the wire terminal block, and when a significant amount of current is flowing into the battery, the voltage drop in the wires may show a slightly different voltage at the battery terminals than at the MX60 terminals because of the voltage drop. When measuring battery voltage ensure a good connection is made to the voltmeter probes. The 4 Position Terminal Block tightening screws do not always make the best connection.

Also, check the battery temperature compensation voltages if voltages are much different than you expect from the **charger** setup Absorb and Float voltage settings.

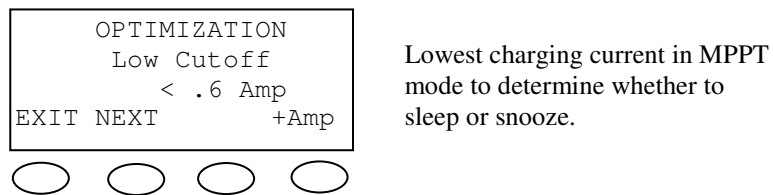
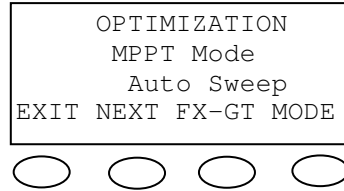

Figure 31. Low Cutoff Amps

**Low Cutoff**

Sets the battery charger lowest current limit that the MX60 will allow to charge in MPPT mode before stopping and going back to sleep. If the battery charge current goes below this setting for a time, the MX60 will go back to sleep. Adjustable from 2 tenths of an Amp to 1 Amp. 06 tenths Amp is the default Low Cutoff current. If you find your MX60 is having a hard time going to sleep, you may try raising this value. The Low Cutoff current setting is also used in the Auto Sweep mode during the initial full panel wakeup sweep to determine if it should snooze for 5 minutes. If the **< Low Cutoff** snooze mode is selected, and if the current during that sweep did not reach the Low Cutoff current setting, the MX60 will snooze.

Selects from the two different MPPT operating modes of the MX60



Select **FX-GT** mode if you have a **GridTied FX, MATE** and **HUB** connected to the MX60. Otherwise, select **non-GT**

Figure 32. MPPT Mode

### MPPT Mode Select (Auto Sweep or U\_Pick)

Selects the basic MPPT mode of the MX60. Auto Sweep MPPT mode (default and preferred MPPT operating mode) does a full (or 1/2) input (PV) sweep (*see minisweep interval*) upon wakeup and then does mini Auto Sweeps from that point on at the selected sweep time interval. U-Pick % (Voc) MPPT mode operates the PV or input Mpp at a selectable percentage of the open circuit panel voltage (*see Optimization Park Mpp %Voc*) and acquires a **New Voc** value every Sweep Interval. The Mpp operating point is derived from the Park MPP setting in U Pick MPPT mode. If minisweep interval is set to 0 minutes, a NewVoc may be acquired once per hour depending on the AutoReStart setting (see LOG2 Auto - ReStart). This is an alternative to the Auto Sweep mode and may also be useful for other applications such as fuel cells.

### FX-GT/non-GT

Select **FX-GT** if you are using a GFX/GVFX Grid-tie series inverter, Hub, and MATE system. Select **non-GT** to disable GT communication and maintain compatibility with older software MATE.

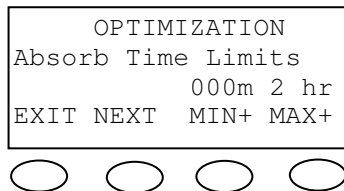

Figure 33. Max Absorb Time

### Absorb Time Limits and Charge Timer

Sets the minimum and maximum amount of time the MX60 is allowed to stay in the Absorb charge stage. MAXimum is adjustable from 1 to 4 hours. MINimum Absorb time is adjustable from 0 minutes up to the maximum absorb time limit... *minus* 10 minutes. For example, if maximum Absorb time is set for 2 hours, then the minimum Absorb time could be adjusted up to 110 minutes.

When a Bulk charge cycle starts first thing in the morning, the charge timer, (*See ChgT miscellaneous 1 screen*) will be preset with the minimum Absorb time limit (default 000). As the MX60 is Bulking/MPPTing, and trying to get the battery voltage up to the Absorb voltage set point, this counter will be counting up in minutes. When the timer reaches the Maximum absorb time it will stop. The charger will continue to put current into the battery and when the Absorb voltage is reached, it will start to count down towards zero. When the charge time reaches zero, then the MX60 will go to the float stage. At this time, the MX60 status display will show **Bat Full**, (battery Full), until the battery voltage drops below the float voltage set point. Then, the status display will show Float and try to keep the battery voltage at the Float set point voltage. If, when in the float stage, the system cannot keep the battery voltage at the float voltage, the MX60 will go back to MPPTing and try to reach that float voltage again. (No timers are involved in controlling the Float stage).

If during the Absorb cycle when the charge timer is counting down, the system is unable to keep the battery voltage at the Absorb voltage set point, the MX60 will return to MPPT and the charge timer will continue counting up towards the Max Absorb time again. This up and down counting will continue until the charge timer counts down to zero. You can also disable the Absorb cycle altogether by setting the minimum and maximum absorb time both to zero.

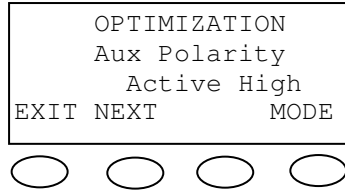

Figure 34. Aux Polarity

### Aux Polarity (Active High / Active Low)

Active Low inverts the Aux Output terminals and supplies 12V when the function is inactive. For example, the Active Low option could turn Low Battery Disconnect mode into a Diversion function. In either case, (Active High or Active Low), “On” (on the LCD) means that **12 volts is present** at the Aux terminals and ”Off” means **0 volts is present** at the Aux terminals.

## (DATA) LOGGING

Figure 35 shows the kilo-Watt Hours (or Amp Hours) and the time (in minutes) that the MX60 spent floating the batteries for each of the last 64 days. The AmpHours or kWh displayed depends on the display setting in the Status screen. Day 01 is yesterday and Day 02 is two days ago, etc. Pressing **-DAY** goes back one day and pressing **+DAY** goes forward one day. If starting on Day 01 and **+DAY** is pressed, the value from 64 days ago is presented. The Total Kilo Amp Hours or Kilo Watt Hours accumulates the daily values and continue beyond 64 days of data. There will be least significant digit data in the Totalized values that may not be displayed until enough data accumulates.

All daily kilo watt /Amp hour readings are DC readings.

Today’s Float time can be found in the **LOG2** screens.

Pressing **CLR** takes you to the Clear Daily and Totals menu and **EXIT** takes you back to the main status screen.

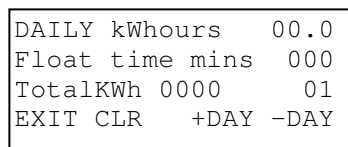

Figure 35. Main Logging Screen

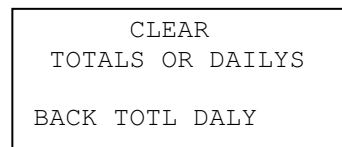

Figure 36. Clear Total logged values

Pressing and holding the **TOTL** or **DALY** button will prompt you to erase those total accumulated values

### Clearing Totals and Daily Stats

Pressing and holding **TOTL** for a few seconds will bring up the “Are you sure?” Screen, prompting you to clear the total accumulated kWh and kAmp statistical values in the MX60. Pressing and holding **DALY** for a few seconds will bring up the “Are you sure” Screen for clearing all of the 64 Daily logged values. After **Yes** is confirmed, the values will be cleared. It may take a few seconds for all 64 daily values to be cleared before the confirmation screen goes away. Pressing **BACK** brings back the Logging screen.

## LOG2

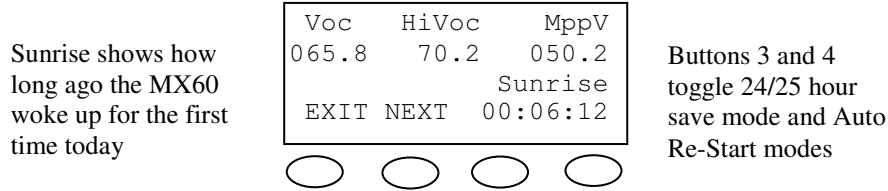

Figure 37. The LOG2 screen

The LOG2 screen shows the last measured open circuit panel voltage (Voc), the highest Voc seen by the MX60, the present Maximum Power Point Voltage being used in the MPPT stage, and the amount of time since the daily and total logged values were updated (**Sunrise**). Sunrise actually shows the last time the daily logging values (*see Logging*) were updated and cleared from the Status screen. This normally happens when the sun first comes up, (first wakeup of the day), and after at least 3 hours of sleeping. After 3 hours of sleeping, the MX60 will display “Zzzz...” This means that the next wakeup will cause all of the daily KiloWAttHour / AmpHour statistics, and Float Time to be logged and accumulated in the Logging screen.

There may be situations where the sun never sets, or PV input never goes away (parts of Alaska), or if a Micro-Hydro or a Fuel Cell is connected to the MX60’s input. In this case, the MX60 will create its own sunrise at either 24 or 25 hours automatically. Pressing and holding down button 3 (in the Log2 screen) for a few seconds will toggle the value between 24 and 25 hours. 25 hour transfer is the default so that sunrise has the first chance at transferring and restarting the Sunrise clock counter in the MX60 since a day can actually be longer than 24 hours.

Holding button 4 down for a few seconds, will select the MX60s Auto ReStart mode. There are 3 ReStart modes -- 0, 1, and 2. AutoStart mode 2 is the default. When the new mode has been changed, the screen will display that number in the center of the LCD until you release button 4.

**Mode 0** indicates the MX60’s Auto ReStart mode is disabled.

**Modes 1** indicates that once every 3 hours, when the MX60 is showing MPPT, it will briefly restart from “Sleeping” and initiate a full panel sweep. This will not reset any counters or charging stages or statistics.

**Mode 2** is similar to **Mode 1**, where in MPPT Auto ReStarts once 3 hours, but with the addition that In Absorb and Float, the MX60 will AutoReStart from sleep once every **4 hours**. Note: Mini-sweeps at the selected sweep interval will initiate on time in either of these modes.

In either Mode 1 or Mode 2, the MX60 will display “**AutoStart**” in the Status screen for a moment.

These Auto ReStarts are mainly so that the MX60 can perform needed recalibration if necessary, and eliminate any possibility of software glitches. An example of when you might want to pick mode 0 is if you have a Micro-hydro connected, and do not want the generator to spin up once every 3 hours.

Pressing **NEXT** will take you to a secondary LOG2 screen that shows the basic charging state of the MX60 (BULK, FLOAT, EQ), FLOAT time in minutes, and the daily maximum (HighWatts) wattage seen by the MX60 during the day.

```

BULK  0000 floatTmin
        0705 HighWatts
        Lo 14.3 Hi 14.9
BACK   DCkWh

```



Figure 38. The secondary LOG2 screen

### Secondary LOG2 Screen

Figure 38 show the secondary LOG screen. The upper left corner shows what charge stage the MX60 is in. It may show Bulk, Absorb, EQ (with elapsed time in Hours and minutes), or Float. If the MX60s Status screen is displaying **MPPT**, this is one way to see which stage, (Bulk or Float) it is actually in. floatTmin shows today’s time (in minutes) spent in the Float stage. This also includes time when the MX60 has gone back to MPPT but still looking to reach the float voltage. It will not accumulate Float time at night and when it is sleeping.

### HighWatts

The **HighWatts** show the daily peak Watts seen by the MX60. When first powering up the MX60, this value will show the Highest Wattage ever registered by the MX60. This number is reset to zero every sunrise just like all of the other daily statistics.

### Lo Hi (Lower, Upper Limits)

The “**Lo Hi**” displays the Lower and Upper battery temperature compensation voltage limits when the **WIDE/LIMIT** mode is set to **LIMIT** (see MISC 1).

### DCkWh/ACkWh

Selects the mode of the display for the Accumulated Total kWh reading in the **logging** screen.

Selecting DCkWh (default) shows DC kiloWatthours and should be used in a non grid tied system.

ACkWh is meant to be used with a GFX or GVFX grid tied system. This mode will adjust the reading to coincide more closely with the AC kiloWatthours being sold to the grid by taking into account system efficiency (about 90% of the DC reading). The heading in the logging screen will change to “TotalKWh AC”.

## APPLICATION NOTES

### Grid-tie applications

When using the MX60 with grid-tie inverters and selling electricity back to the grid, keep the inverter float voltage below the MX60 float voltage. This ensures that the MX60 is always trying to keep the battery voltage above the voltage that the inverter will be selling back. A 0.5 Volts difference for 24V battery system or 1.0 volt difference for 48V battery systems is a good rule of thumb. Example: MX60 Float voltage = 54.4v.

Inverter Float voltage = 53.4v.

### Diversion using hydro or wind power

When the wind or hydro generator is connected to the battery terminals as an external DC source, keep the MX60s diversion voltage slightly above the MX60s Absorb and Float voltages so the MX60 can do it's job, but the wind and/or hydro DC sources stay slightly out of the way voltage wise.

### Positive grounded systems

Telcom applications frequently require a positive grounded system. Just remember that the MX60 switches the POSITIVE PV and battery leads and needs to keep those separate. It is suggested to ground ONLY the battery positive lead in this case (if code allows it). Do not connect the MX60's battery plus to the PV plus input while the MX60 is running.

### OutBack Power System GFX/GVFX Grid-tie settings

In a GFX/GVFX series inverter, MX60 and HUB installation, ensure that MX60 is set to "FX-GT" mode in the Optimization setup menu (see page 25). The "FX-GT" mode allows the GFX/GVFX series inverter to *manage* the float setting of the MX60 to ensure that the MX60 is always keeping the battery above the sell voltage of the GFX/GVFX series inverter.

### Battery temperature compensation with other slopes

The MX60 uses a 5mV per degree C per cell (2V) compensation slope required by UL if you run the MX60 at or near the default system voltages. If you need to use slopes other than this, you may be able to pick a system voltage other than the one you are running, and change the charger Absorb and Float voltage settings up or down from that default setting to achieve a more or less aggressive slope. If going lower in voltage, reduce the Float voltage first, since the Absorb voltage will not be adjustable below the Float voltage setting. If going higher in voltage, increase the Absorb setting first, before raising the Float voltage above the present setting. Here is a table of MX60 compensation based on system voltage for reference:

|            |                 |
|------------|-----------------|
| 12V system | -30mV/degree C  |
| 24V system | -60mV/degree C  |
| 36V system | -90mV/degree C  |
| 48V system | -120mV/degree C |
| 60V system | -150mV/degree C |

## CALLING THE FACTORY FOR ASSISTANCE

When calling OutBack Power for product assistance, please have the following information ready if possible:

1. **MX60 Serial number** and **software version**. The software version can be viewed by exiting the Status screen to the Main menu screen, and then exiting the menu screen back to the Status screen and holding down the EXIT key.
2. The **nominal PV array** and **battery voltage**.
3. The PV array operating voltage and battery current and any Status screen operational mode displays, such as MPPT, Absorbing (Absorb) or Float.

### BASIC MX60 BLOCK DIAGRAM

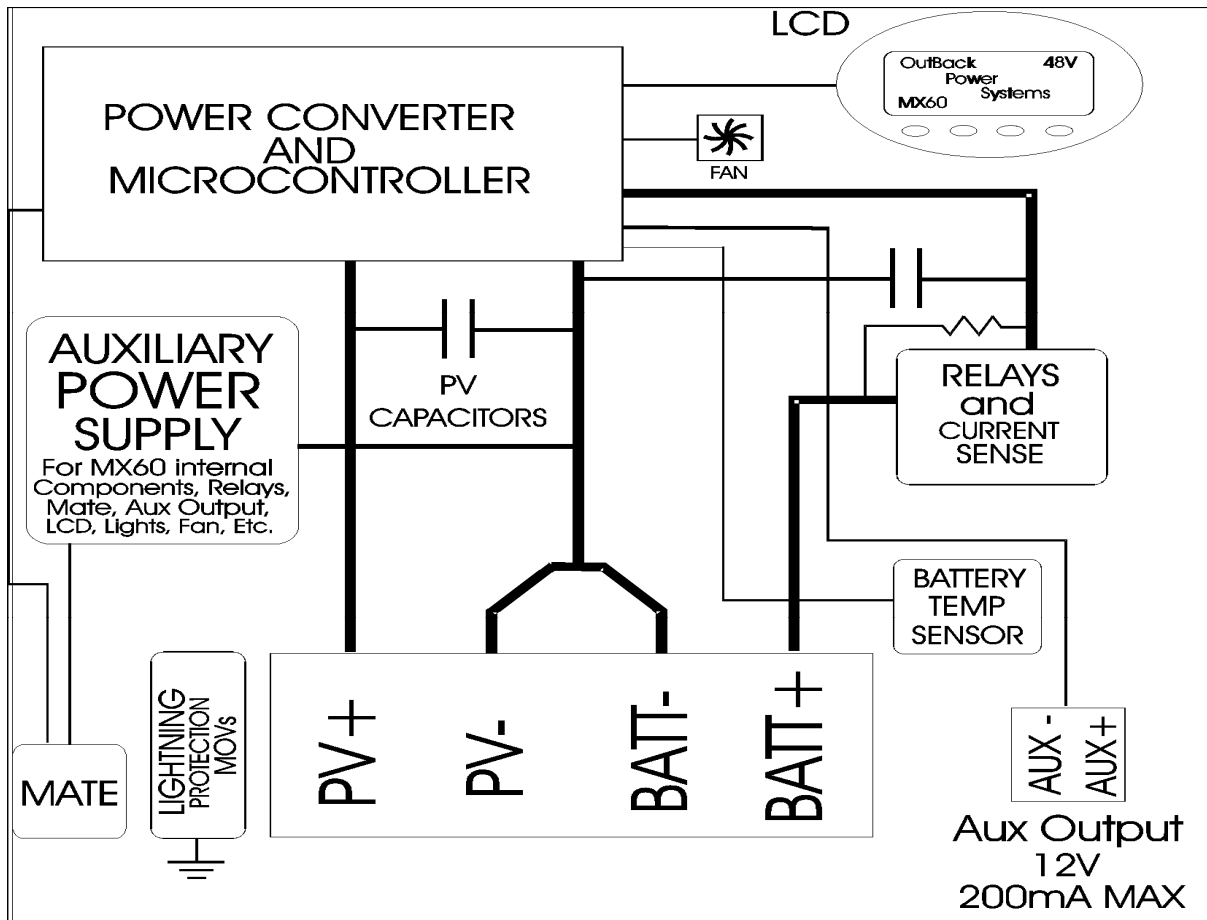

## SPECIFICATION

|                                 |   |
|---------------------------------|---|
| Output Current Rating:          | 60 Amps   |
| Default Battery System Voltage: | 12, 24, 36, 48 or 60VDC (adjustable)  |
| PV open circuit voltage:        | 150v DC Maximum (ETL Rating for UL1741 Standard)  |
| Standby power consumption:      | Less than 1 watt typical  |
| Charging regulation methods:    | Five stage: Bulk, Absorption, Silent (Battery Full), Float , Equalization   |
| Voltage regulation set points:  | 13-80VDC  |
| Temperature compensation:       | With optional sensor 5 millivolts <sup>0</sup> C per 2V cell  |
| Voltage step down capability:   | Down-convert from any PV array voltage within PV voc limits of 150V to any battery system voltage. Examples: 72V array to 24V; 60V array to 48V |
| Digital Display:                | 4 line 20 character per line backlit LCD display  |
| Remote Interface:               | RJ45 modular connector Cat 5 cable 8 wire   |
| Operating Temperature Range:    | -40° to 60°C de-rated above 25°C  |
| Environmental Rating:           | Indoor type 1   |
| Conduit knockouts:              | Two 1/2-3/4" on the back; one 3/4-1" on each side; two 3/4-1" on the bottom   |
| Warranty:                       | Two years parts and labor, optional extended warranty available   |
| Dimensions:                     | Unit: 14.5"H x 5.75"W x 5.75"D Boxed: 17.8"H x 10W x 7"D  |
| Weight:                         | Unit 12 pounds Boxed 15 pounds  |

### MX60 EFFICIENCY Vs. INPUT POWER GRAPH

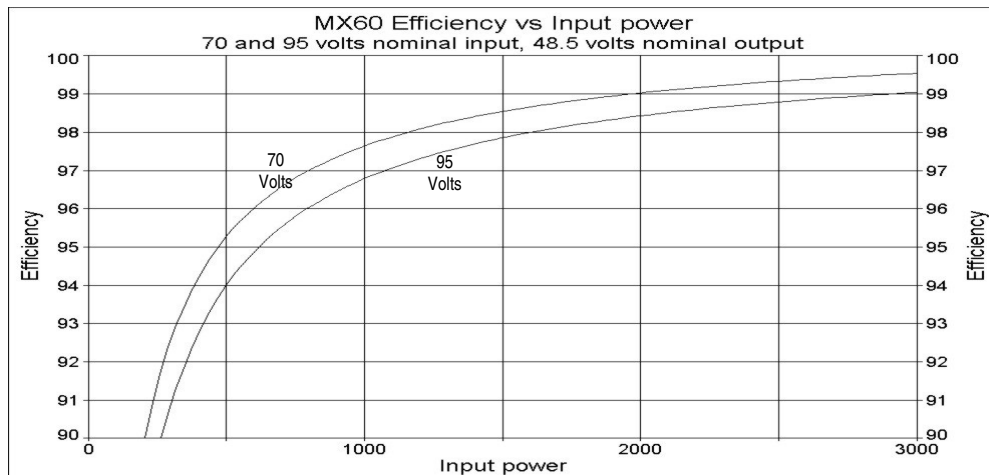
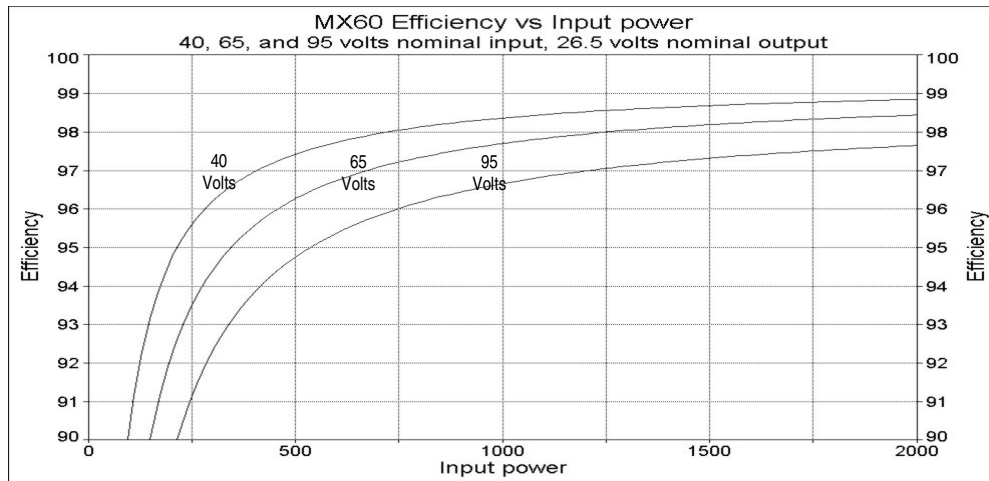

# APPENDIX A – OBDC GFP/2 INSTALLATION

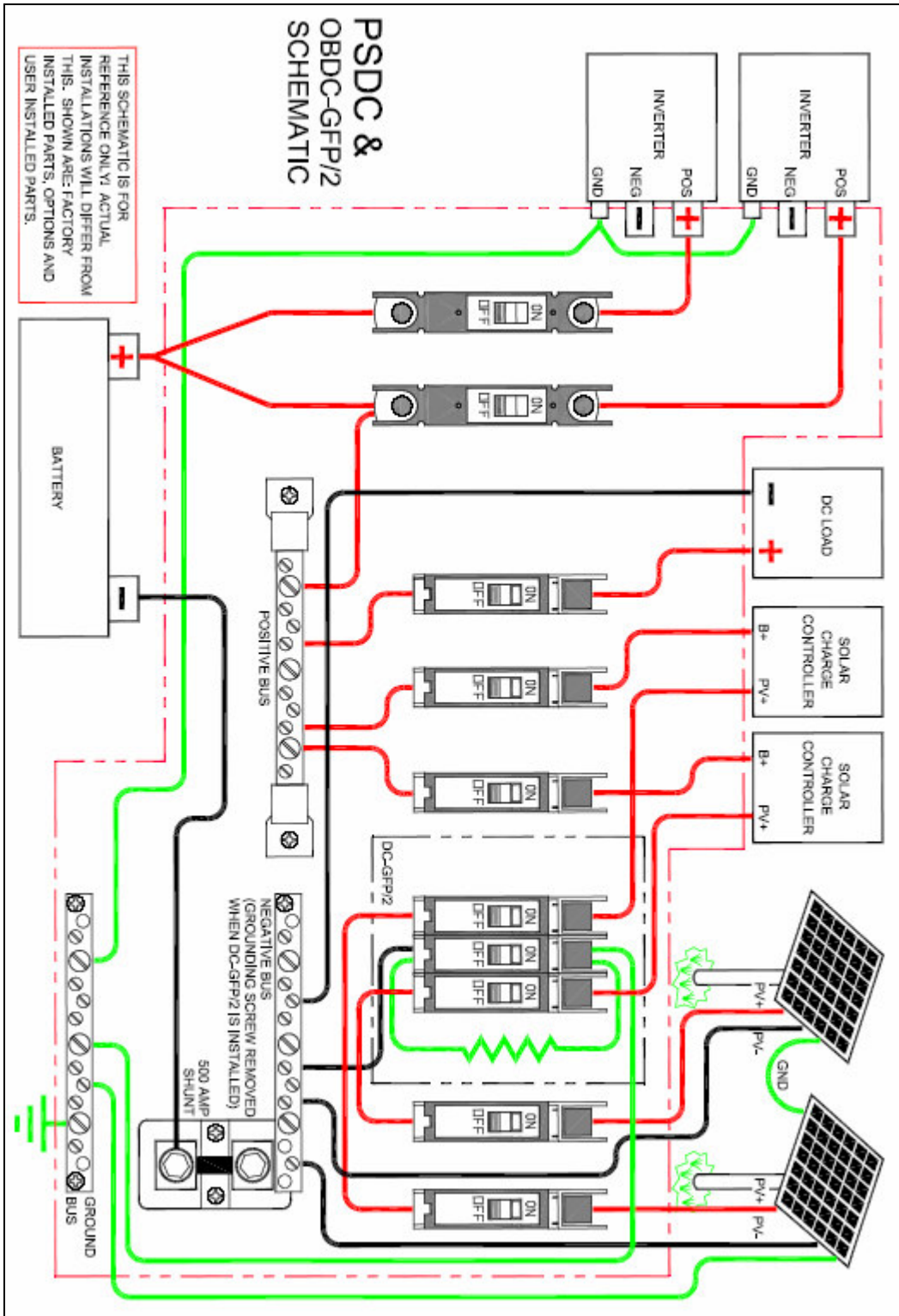

Note: Do NOT tie the negative and ground cables on the same ground or negative busbar when installing the OBDC GFP/2.



## APPENDIX C – 120V BATTERY CHARGING APPLICATION

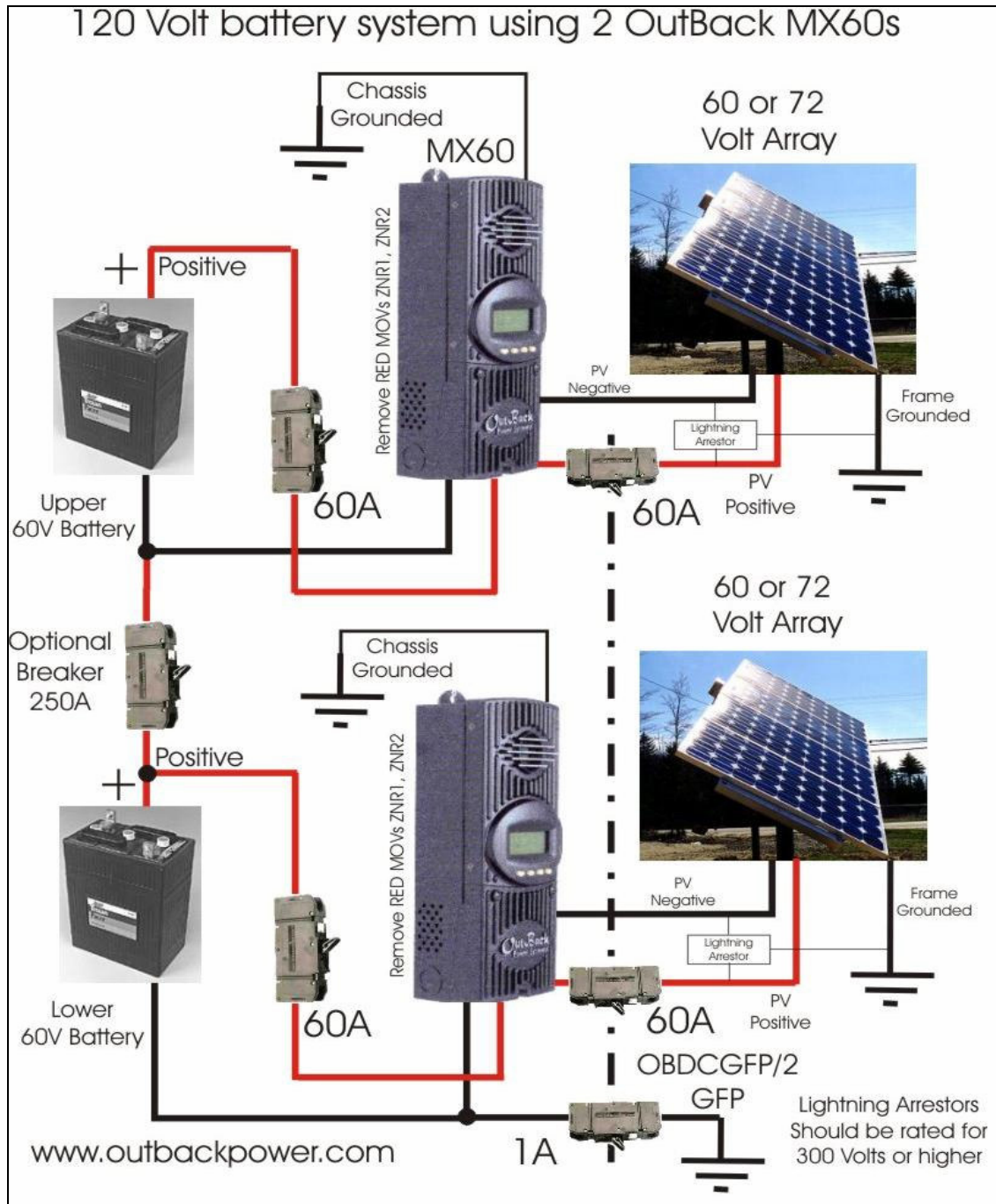

Charging a 120 volt battery is possible by inter-connecting 2 MX60 charge controller in series with 2 banks of 60 volt batteries in series. A 72 volt nominal array is recommended for this particular setup. Accordingly, charging a 72 volt battery bank can be accomplished using the same method by using 2 series banks of 36v batteries. Please feel free to contact us regarding this (or a similar) setup.

## APPENDIX D – UNDERSTANDING THE VARIOUS OPERATIONAL MODES

The modes of operation will change occasionally during the day based on PV array output and battery system state of charge. The MX60 operating modes are displayed at the bottom right hand corner of the Status screen.

**Sleeping** PV voltage is less than battery voltage or charger current is below the minimum cutoff (Lowcutoff) current. This may also appear briefly during the day when the MX60 is transitioning between certain states, and because of other conditions.

**Zzzz...** At night (3 hours of Sleeping) the MX60 will display **Zzzz...** until the next wakeup. At the next wakeup, (usually the next morning), the daily statistics, (AmpHours, KWh, etc.), will accumulate into the total statistics and then the displayed daily statistics will clear.

**Wakeup** As the PV open circuit voltage, (Voc), rises above the battery system voltage by ~2 volts, the MX60 prepares to deliver power to the batteries. During this period, the MX60 is calculating the PWM duty cycles, turning on power supply voltages in the proper sequences, and making internal calibrations. At wakeup, the MX60 closes its relays and will then start sweeping the input voltage, (the “initial” sweep), towards the battery voltage. At dawn and dusk this may happen many times until there is (or is not) enough power from the PV array to keep going. Wakeup is also a time when the MX60 acquires a new Voc.

**Sweeping** In Auto-Sweep MPPT mode, the MX60 is either doing an initial sweep of the panel voltage from Voc towards battery voltage after wakeup, or is doing a periodic dithering mini-sweep to stay on the max power point. Below 5 amps of battery output current, this will flash briefly as the MX60 operates at the **Park Mpp** voltage. This message may also appear briefly if the MX60 has reached the max battery current setting and is raising the PV operating voltage to keep the battery current from exceeding the maximum battery output current limit setting.

**MPPT** The MX60 is in Maximum Power Point Tracking mode and is trying to get the battery voltage to reach the Absorb or Float voltage set point in the Bulk or Float charge stages. If the MX60 is in the Bulk charge stage, the Charge Timer (ChgT), will count up to the max Absorb time.

**Absorbing** The MX60 is in the Absorb (constant voltage) charge stage, keeping the battery voltage at the Absorb voltage set point, (modified by battery temperature compensation if installed), and the ChgT counter in the miscellaneous screen is counting down towards zero from however long the MX60 was in Bulk. If the system cannot keep the battery voltage at the Absorb voltage set point, then the MX60 will return to the Bulk charge stage, display MPPT, and the ChgT counter will start counting up again towards the MAX Absorb time set point.

**Absorb** There is an external DC source (wind generator/hydro) keeping the battery at or above the Absorb set point.

**Bat Full** The MX60 is waiting for the battery voltage to fall to below the Float voltage set point before continuing with the Float stage. This may also be displayed when external DC charging sources are present.

**Float** The MX60 is in the Float charge stage and is keeping the battery at the Float voltage set point. If the system cannot keep up with the Float voltage set point, (e.g. DC loads are on), then the MX60 will return to MPPTing, display MPPT, and try it's best at again reaching the Float set point target voltage.

**New Voc** The MX60 is acquiring a new open circuit panel voltage periodically in the U-Pick MPPT mode.

**Re-Cal** There are certain abnormal conditions that can confuse the current measuring method in the MX60. When and if this happens, the MX will temporarily stop and re-calibrate. This may sometimes happen because of negative current, i.e., current coming out of the input terminals instead of into the input terminals, or a tripped PV breaker. A new Voc is also acquired during a Re-Cal.

**Bat Tmp Err** The battery temperature sensor is shorted or damaged.

**EQ MPPT** The equalization process has been manually started and the MX60 is seeking the Equalization voltage set point (EQ is **NOT** battery temperature compensated). The AUX output will be disabled in all but the Manual On mode. After the EQ voltage has been reached, EQ 0:00 will be displayed and the EQ time in hours and minutes will be displayed. The DC loads should be turned off and the battery should be charged enough so that the MX60 can reach the EQ voltage set point, otherwise the MX60 cannot start the EQ cycle.

**EQ 0:00** This message shows that the EQ cycle has started and shows how long it has progressed in Hours:minutes.

**EQ DONE** Once the set EQ time, (1 to 7 hours), has successfully completed, EQ DONE will be displayed either until a button is pressed, or the next morning's wakeup.

**Low Light / Snoozing** During the initial sweep, (see Wakeup and Sweeping), if it is determined that it is too late (or too early), in the day, the MX60 will display Low Light for a few seconds, then display Snoozing for 5 minutes, which is a form of sleeping. This is meant to reduce energy and unnecessary powering of the MX. This can, of course, be displayed in extremely cloudy weather. The snoozing mode can be disabled and has 2 basic modes to choose from. One mode is based on the speed of the ability of the PV to charge the input capacitors and another mode looks at the initial wakeup sweep current to see if it reached the low cutoff (default) current set point.

**Unloaded** The battery terminals were abruptly unloaded. May be displayed if the battery breaker trips while MPPTing or the system voltage is set too low.

**AutoStart** (Auto Re-Start) Once every 3 hours, in MPPT mode, and once every 4 hours, in the Absorb and Float charge modes, the MX60 will start over from sleep and re-sweep (full sweep) and re-calibrate the current sensor. This can either be disabled completely, selected to only Auto Re-Start in MPPT mode, or Re-Start in MPPT and Absorb/Float charge mode. It is recommended that this mode be left to mode 2, Auto Re-Start in all 3-charger modes. (See LOG2 screen)

**MXTooHot** (Very rare) Either the MX60 is just too hot or its internal temperature sensor is shorted. If you do get this message, check (very carefully) to see if the MX60 is really hot on the outside heatsink. The heat generated by the MX60, and therefore its losses, are proportional to input voltage times output current. It is also a good idea **NOT** to install the MX60 in direct sunlight.

**SysError** (Very rare) System Error indicates an internal non-volatile memory error. The unit will stop operating when this message is displayed. Call the factory if you see this message.

**PV COLD** This indicates that the PV array's open circuit voltage is too high for the controller to safely operate. This should only occur with systems using 72v DC nominal PV arrays in very cold temperatures (below 5 °F / -15 °C). The controller will automatically restart operation once the PV array's open circuit voltage falls to a safe level (135v). The amount of time required for it to reset is dependant on the module type, ambient temperature, and the amount of sunlight directly on the PV array. Normally, the controller will start-up in the morning within a few minutes of the PV array being in direct sunlight. Reconfiguring the PV array for a 48v DC nominal will eliminate this from occurring.

## APPENDIX E – TROUBLESHOOTING GUIDE

### **MX60 does not boot/power-up (blank LCD)**

1. Check battery connection and polarity  
Reverse polarity or improper connection will cause power-up issues.
2. Check the battery breaker  
Ensure that the battery breaker is sized appropriately.
3. Is the battery voltage greater than 10.5v? (Measure the battery-side of 4 Position Terminal block)  
A battery voltage below 10.5v may not power up the MX60
4. If the MX60 still does not power up, call the factory for additional support

### **MX60 is always SLEEPING**

1. Is battery voltage greater than the ABSORB voltage set point (compensated ABSORB voltage)?  
If yes, the MX60 will not wake up since the battery voltage is at/above the ABSORB target voltage set point
2. Is the PV voltage greater than the battery voltage by at least 2 volts?  
The PV voltage has to be at least 2 volts greater than the battery voltage for the initial wakeup.
3. Check the PV array breaker (or fuse)  
Ensure that the PV array breaker (or fuse) is sized appropriately.
4. Which **State** (in **Misc** Menu) is it at? Is it transitioning between 00 and 01? Is it in FX-GT mode and connected to a MATE?  
Disconnect MATE for normal operation in FX-GT\* mode.  
\*FX-GT mode is only applicable with a Hub 4 or 10 installation with a Grid-tie compatible MATE.
5. Does the PV array voltage on the display rise with the PV breaker OFF, but reads 000 with the PV breaker on?  
If so, the PV array polarity connection on the MX60 maybe reversed or the PV lines could be shorted.
6. Does the PV voltage still read 000 with the PV breaker off after a minute?  
Call factory for support
7. Check the short circuit current of the PV array?  
Use a multimeter to determine if a short circuit current is detected. The short circuit current test will not harm the array

### **MX60 not producing expected power**

1. Is it cloudy and/or is there shading on the panels?  
Clouds, partial shading (or dirty panels) can cause poor performance
2. What is the current limit set to?  
A lower current limit set point (“charger” menu) will yield a loss of power or poor performance symptoms
3. Are the batteries charged? Is the MX60 in the Absorbing or Float stage?  
If so, the MX60 will produce enough power to regulate the voltage at the ABSORB or FLOAT set point voltage, therefore, requiring less power in these modes.
4. What is the short circuit current of the PV array?  
Use a multimeter to determine if a short circuit current is as expected. There might be a loose PV array connection.

### **MX60 not producing expected power (continued.....)**

5. Is the PV array voltage close to the battery voltage?

If so, the panels could be warm/hot causing the Maximum Power Point to be at or lower than the battery voltage.

6. Is the SWEEP INTERVAL set to 00 mins?

If so, the MX60 will not periodically find the Maximum Power Point of the array.

A sweep interval of 7 min to 10 min is suggested

### **MX60 is not equalizing**

1. Has the EQ cycle been initiated?

In the EQ menu press START to begin process. When the EQ cycle has been initiated “EQ MPPT” will be displayed

2. The EQ cycle has been initiated, but the battery is not equalizing

The EQ cycle will begin when the target EQ set point voltage has been reached. A small array or a cloudy weather will delay the EQ cycle. Accordingly, too many AC and/or DC loads on will delay the EQ cycle too.

3. What is the EQ set point relative to the battery voltage?

An EQ set point that is too high relative to the battery voltage will delay the EQ cycle. *See answer of step 2 above*

4. Is the PV array voltage close to the battery voltage?

If so, the panels could be warm/hot causing the Maximum Power Point to be at or lower than the battery voltage, hence delaying the EQ cycle.

### **MX60 Sweeping frequently**

1. What is the sweep interval set point?

A short sweep interval time will cause the MX60 to sweep frequently. A sweep interval of 7 to 10 minutes is recommended.

2. What is the current limit set point?

When the current limit set point is achieved the MX60 will continue to sweep to maintain the targeted current limit.

### **MX60 Battery Temperature Compensated Voltage**

1. Can I use a Battery Temperature Sensor (BTS) other than the OutBack BTS/RTS?

No!

2. Why is the battery voltage above/below the ABSORB and FLOAT voltage set points?

The battery voltage can rise above the ABSORB and FLOAT voltage set points if the battery temperature is  $< 77^{\circ}\text{F}$  or fall below the ABSORB and FLOAT voltage if the battery temperature is  $> 77^{\circ}\text{F}$ .

To view the battery compensated voltages, please reference page 21.

3. Why does the MX60 show “BatTmpErr” on the STATUS screen?

The BTS is faulty/damaged. Disconnect the BTS from the BTS jack to resume normal operation.

### **MX60 Internal Fan**

1. Should the internal fan be running when the MX60 is producing power?

The internal fan will only run when the internal temperature has reached  $\sim 115^{\circ}\text{F}$ .

2. How long does the internal fan run?

The internal fan will run as needed. In the MISC menu, the fan will run, if and only if, the value of PCB is lower than the value **350**

## APPENDIX F – TYPICAL ARRAY SIZING GUIDE

Below is a list of recommended array sizing for the MX60 charge controller for various nominal voltage batteries:

| <b>Nominal Battery Voltage</b> | <b>Recommended Array Size (in watts)</b> |
|--------------------------------|--|
| 12v                            | 800w                                     |
| 24v                            | 1600w                                    |
| 36v                            | 2400w                                    |
| 48v                            | 3200w                                    |
| 60v                            | 4000w                                    |

The MX60 charge controller is capable of an input PV voltage of 150v open-circuit. However, cooler climates can cause the open circuit voltage ( $V_{OC}$ ) to rise above the panel Voc rating, therefore, in climates that observe temperatures less than  $\sim 5^{\circ} F$ , a Voc greater than 125v is **not** recommended.

When sizing an array for a system it is recommended that the nominal array voltage be higher than the nominal battery voltage. Below is a list of recommended nominal array sizing:

| <b>Nominal Battery Voltage</b> | <b>Nominal Array Voltage (<i>recommended</i>)</b>                                  |
|--------------------------------|--|
| 12v                            | 24v (or higher)*   |
| 24v                            | 36v (or higher)*   |
| 36v                            | 48v (or higher)*   |
| 48v                            | 60v (or higher)*   |
| 60v                            | 60v (if low temp $< \sim 5^{\circ} F$ ) or 72v (if low temp $> \sim 5^{\circ} F$ ) |

\* When sizing an array to charge controller with a distance of 70 feet or greater it is recommended that the nominal array voltage be slightly higher than the ***recommended*** nominal array voltage. Example, a 36v nominal array charging a 12v nominal battery with an array to charge controller distance of about 70 feet or greater.

Sizing the nominal array voltage higher than the nominal battery voltage will ensure that the Maximum Power Point is always above the battery voltage. The Maximum Power Point of an array will decrease as the panels warm up, thus lowering the output of the array. The MX60 charge controller will not be able to boost the output if the Maximum Power Point of the array is at or lower than the battery voltage.

## APPENDIX G – STANDARD vs. AUSTRALIAN DEFAULT SETTINGS

The Australian version MX60 charge controller has a few default settings that differ from the Standard version default settings, however, there are no differences in performance and efficiency between the two versions. The Standard and Australian version can be identified as follows:

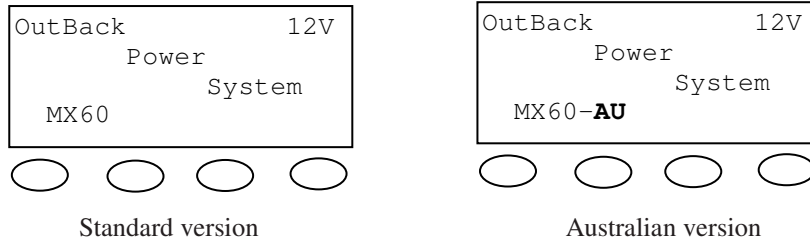

Below are a few default setting differences between the Standard and Australian version.

| <b>Settings</b>      | <b>Standard</b>       |        |       | <b>Australian</b>     |        |       |
|----------------------|-----------------------|--------|-------|-----------------------|--------|-------|
| <b>Charger</b>       | Amps                  | Absorb | Float | Amps                  | Absorb | Float |
| 12v                  | 60                    | 14.4v  | 13.6v | 60                    | 14.4v  | 13.8v |
| 24v                  | 60                    | 28.8v  | 27.2v | 60                    | 28.8v  | 27.6v |
| 36v                  | 60                    | 43.2v  | 40.8v | 60                    | 43.2v  | 41.4v |
| 48v                  | 60                    | 57.6v  | 54.4v | 60                    | 57.6v  | 55.2v |
| 60v                  | 60                    | 72.0v  | 68.0v | 60                    | 72.0v  | 69.0v |
| <br>                 |                       |        |       |                       |        |       |
| <b>Equalize</b>      | <b>Equalize Volts</b> |        |       | <b>Equalize Volts</b> |        |       |
| 12v                  | 14.4                  |        |       | 14.7                  |        |       |
| 24v                  | 28.8                  |        |       | 29.4                  |        |       |
| 36v                  | 43.2                  |        |       | 44.1                  |        |       |
| 48v                  | 57.6                  |        |       | 58.8                  |        |       |
| 60v                  | 72.0                  |        |       | 73.5                  |        |       |
| <br>                 |                       |        |       |                       |        |       |
| <b>Equalize Time</b> | <b>01 Hours</b>       |        |       | <b>03 Hours</b>       |        |       |

## APPENDIX 1 – MX60 MULTI-STAGE BATTERY CHARGING

The MX60 charge controller is a sophisticated multi-stage battery charger that uses several regulation stages to allow fast recharging of the battery system while ensuring a long battery life. This process can be used with both sealed and non-sealed batteries. The MX60 will automatically set the charging regulation voltage set points (Absorb & Float) for the selected nominal battery voltage, however, always follow the battery manufacturer's recommended charging regulation voltages. The MX60 charging regulation stages correspond to the chart below.

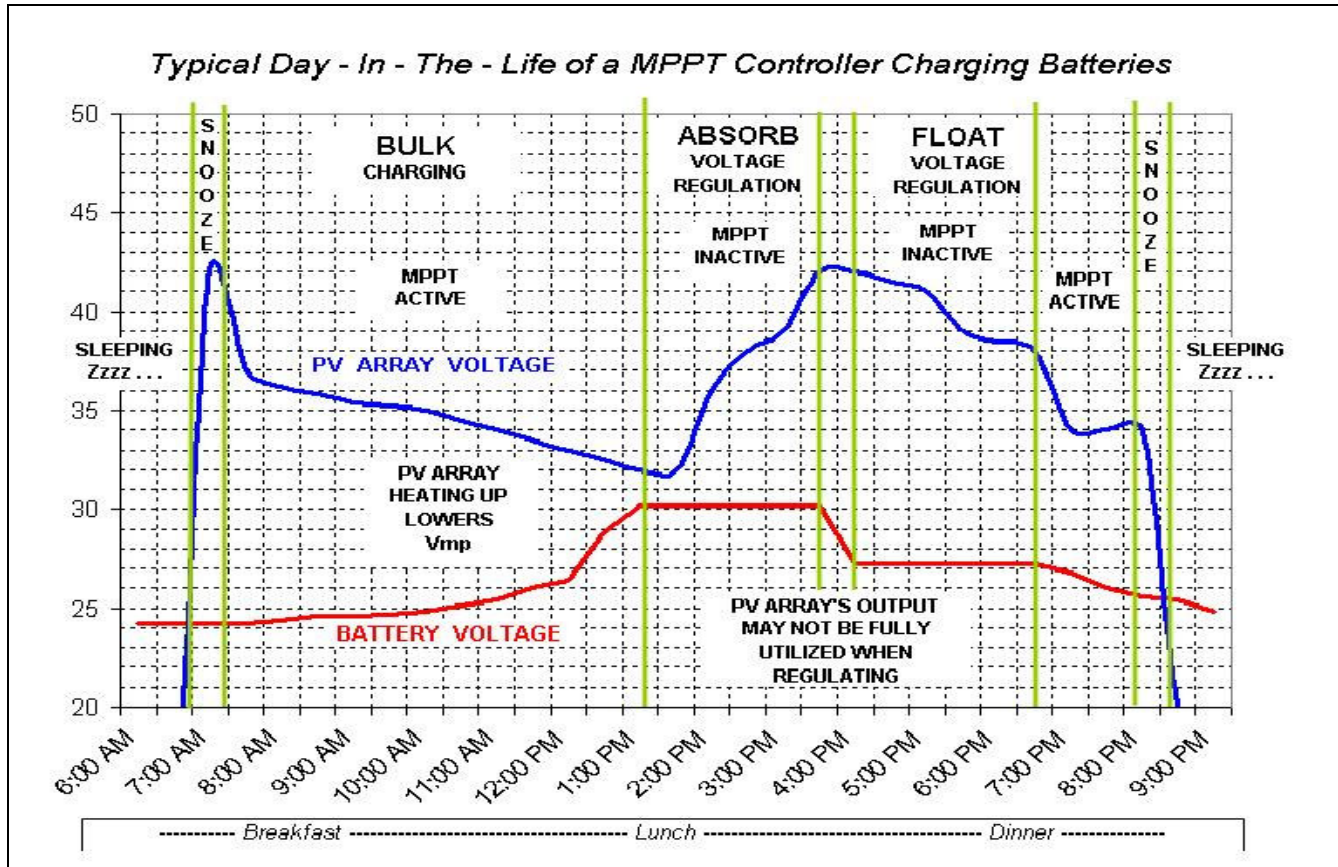

### **BULK** This stage provides the maximum power to the battery -- voltage increases while charging

A Bulk charge is automatically initiated when the battery voltage is below the Absorb and Float voltage set points. The Bulk charge will continue until the Absorb voltage set point is achieved.

### **ABSORBING** This stage limits the amount of power going to the battery -- the voltage is held constant

The Absorb charge will continue for the duration of the Bulk cycle or until the 2 hour (default) Absorb time limit is reached. Example, if a Bulk charge takes 1 hour to reach the Absorb voltage set point then the Absorb charge will continue for 1 hour as well. However, if a Bulk charge takes 3 hours to reach the Absorb voltage set point then the Absorb charge will continue for 2 hours only. A Bulk charge will be re-initiated if the battery voltage is not sustained at the Absorb voltage set point.

### **FLOAT** This stage reduces the charging voltage to prevent overcharging of the batteries

A Float charge follows after the Absorb charge is completed. The MX60 **will not** re-initiate another Bulk charge if the Float voltage set point is not sustained, however, it will continue to charge the battery until the Float voltage set point is achieved. Note: A Bulk charge can be initiated if the battery voltage falls below the Float voltage set point if the re-Bulk (ReBV) voltage option is set.

## APPENDIX 2 – BATTERY TEMPERATURE COMPENSATED VOLATGE SET POINT

The temperature of a battery has an impact on the charging process -- in higher ambient temperatures, the regulation set points (Absorb & Float) need to be reduced to prevent overcharging of the batteries. However, in lower ambient temperature conditions the regulation set points need to be increased to ensure complete recharging of the batteries.

The default charger settings of the MX60 are based on typical lead acid battery systems. *Always ensure that the Absorb & Float voltages are set to the recommended battery manufacturer's charging regulation voltages.*

### Non-Battery Temperature Compensated System

If a battery temperature sensor is not available the Absorb and Float voltage set points can be adjusted for the expected weather conditions. The following table shows the appropriate adjustments for both Absorb and Float voltage set points for weather conditions above or below 77°F / 25°C

| EXPECTED TEMPERATURE  | ADJUST SETPOINT | 12v   | 24v   | 48v   |
|-----------------------|-----------------|-------|-------|-------|
| Average = 95°F / 35°C | Subtract        | 0.30v | 0.60v | 1.20v |
| Average = 86°F / 30°C | Subtract        | 0.15v | 0.30v | 0.60v |
| -----                 |                 |       |       |       |
| Average = 68°F / 20°C | Add             | 0.15v | 0.30v | 0.60v |
| Average = 59°F / 15°C | Add             | 0.30v | 0.60v | 1.20v |

### Battery Temperature Compensated System

A battery temperature sensor will **automatically** compensate the Absorb & Float voltage **relative** to the Absorb and Float set points in the “**charger**” menu. Please reference page 18 and 21 of this manual for adjusting the upper and lower battery compensated limits.

*\*\* Always ensure that the Absorb and Float charging regulation voltages are set to the recommended battery manufacturer's set points \*\*.*

## APPENDIX 3 – SUGGESTED BATTERY CHARGER SET POINTS

The battery manufacturer should provide you with specific instructions on the following maintenance and charging regulation set point limits for the specific batteries. The following information can be used when the manufacturer's information is not available.

|                                     |            |            |            |
|-------------------------------------|------------|------------|------------|
| <b>SEALED LEAD ACID – AGM / GEL</b> | <b>12v</b> | <b>24v</b> | <b>48v</b> |
| ABSORB voltage set point            | 14.4v      | 28.8v      | 57.6v      |
| FLOAT voltage set point             | 13.4v      | 26.8v      | 53.6v      |
|                                     |            |            |            |
| <b>NON-SEALED LEAD ACID</b>         | <b>12v</b> | <b>24v</b> | <b>48v</b> |
| ABSORB voltage set point            | 14.8v      | 29.6v      | 59.2v      |
| FLOAT voltage set point             | 13.4v      | 26.8v      | 53.6v      |

Note: Higher settings can be used with non-sealed batteries, but water consumption will be greater and excessive temperatures when charging may occur

### Battery Voltage and State of Charge

The DC voltage of a battery can be used as a guideline to estimate the amount of power stored in the battery that is available for use. When referencing the battery voltage on the display – ensure that the battery is not under significant charging or heavy loads otherwise the DC voltage is not reflective of the battery state of charge. Often the best time to check the battery voltage is in the morning (pre-charging) or at night (post-charging).

Operation of a battery below 50% state of charge will adversely affect the long term health of the battery system and will result in premature failure. Keeping the battery above the 50 % level and recharging it completely once a month will ensure proper operation and good performance.

| Nominal<br>Battery Voltage | State of Charge |             |                |            |             |
|----------------------------|-----------------|-------------|----------------|------------|-------------|
|                            | CHARGED         | GOOD (~75%) | AVERAGE (~50%) | LOW (~25%) | DISCHARGED  |
| 12v                        | over 12.6v      | 12.3v       | 12.0v          | 11.7v      | under 11.4v |
| 24v                        | over 25.2v      | 24.6v       | 24.0v          | 23.4v      | under 22.8v |
| 48v                        | over 50.4v      | 49.2v       | 48.0v          | 46.8v      | under 45.6v |
| 60v                        | over 63.0v      | 61.5v       | 60.0v          | 58.5v      | under 57.0v |



## TWO YEAR LIMITED WARRANTY INFORMATION

OutBack Power Systems Inc. warrants that the products it manufactures will be free from defects in materials and workmanship for a period of two (2) years subject to the conditions set forth below.

The limited warranty is extended to the original user and is transferable. The limited warranty term begins on the date of invoice to the original user of the product. The limited warranty does not apply to any product or part thereof damaged by a) alteration or disassembly, b) accident or abuse, c) corrosion, d) lightning, e) reverse polarity, f) repair or service provided by an unauthorized repair facility, g) operation or installation contrary to instructions pertaining to the product. OutBack Power Systems' liability for any defective product or any part thereof shall be limited to the repair or replacement of the product, at OutBack Power Systems' discretion. OutBack Power Systems does not warrant or guarantee the workmanship performed by any person or firm installing its products.

THIS LIMITED WARRANTY GIVES YOU SPECIFIC LEGAL RIGHTS, AND YOU MAY ALSO HAVE OTHER RIGHTS THAT VARY FROM STATE TO STATE (OR JURISDICTION TO JURISDICTION). OUTBACK POWER SYSTEMS' RESPONSIBILITY FOR MALFUNCTIONS AND DEFECTS IN HARDWARE IS LIMITED TO REPAIR AND REPLACEMENT AS SET FORTH IN THIS LIMITED WARRANTY STATEMENT. ALL EXPRESS AND IMPLIED WARRANTIES FOR THE PRODUCT, INCLUDING BUT NOT LIMITED TO ANY IMPLIED WARRANTIES OF AND CONDITIONS OF MERCHANTABILITY AND FITNESS FOR PARTICULAR PURPOSE, ARE LIMITED IN DURATION TO THE LIMITED WARRANTY PERIOD SET FORTH ABOVE AND NO WARRANTIES, WHETHER EXPRESS OR IMPLIED, WILL APPLY AFTER SUCH PERIOD. SOME STATES (OR JURISDICTIONS) DO NOT ALLOW LIMITATIONS ON HOW LONG IMPLIED WARRANTY LASTS, SO THE ABOVE LIMITATION MAY NOT APPLY TO YOU.

OUTBACK POWER SYSTEMS DOES NOT ACCEPT LIABILITY BEYOND THE REMEDIES SET FORTH IN THIS LIMITED WARRANTY STATEMENT OR LIABILITY FOR INCIDENTAL OR CONSEQUENTIAL DAMAGES, INCLUDING WITHOUT LIMITATION ANY LIABILITY FOR PRODUCTS NOT BEING AVAILABLE FOR USE. SOME STATES (OR JURISDICTIONS) DO NOT ALLOW THE EXCLUSION OR LIMITATION OF INCIDENTAL OR CONSEQUENTIAL DAMAGES, SO THE ABOVE EXCLUSION OR LIMITATION MAY NOT APPLY TO YOU.

During the two year period beginning on the invoice date, OutBack Power Systems will repair or replace products covered under this limited warranty that are returned to OutBack Power Systems' facility or to an OutBack Power Systems authorized repair facility, or that are repaired on site by an OutBack Power Systems authorized repair technician. To request limited warranty service, you must contact OutBack Power Systems at 360-435-6030 within the limited warranty period. If limited warranty service is required, OutBack Power Systems will issue a Return Material Authorization (RMA) Number. Mark the outside of the package with the RMA number and include a copy of the purchase invoice in the package. You must ship the products back to OutBack Power Systems in their original or equivalent packaging, prepay shipping charges, and insure the shipment or accept the risk of loss or damage during shipment. OutBack Power Systems will ship the repaired or replacement products to you freight prepaid if you use an address in the continental United States, where applicable. Shipments to other locations will be made freight collect.

## REGISTER YOUR PRODUCT(S)

Your purchase of an OutBack Power Systems product is an important investment. Registering your products will help us maintain the standard of excellence you expect from us in terms of performance, quality and reliability.

Please take a moment to register and provide us with some important information.

Name: \_\_\_\_\_

Address: \_\_\_\_\_

City, State, Zip Code: \_\_\_\_\_

Country: \_\_\_\_\_

Telephone Number: \_\_\_\_\_

E-mail: \_\_\_\_\_

Sold by: \_\_\_\_\_

Installer: \_\_\_\_\_

Purchase Date: \_\_\_\_\_

Model Number: \_\_\_\_\_

Serial Number: \_\_\_\_\_

Check all that apply:

- Off-Grid Installation
- Grid-Tie Installation
- Residential Installation
- Commercial Installation

**This registration form can be removed from the MX60 Manual, folded, and mailed using the address on the reverse side.**

### EXTENDED WARRANTY APPLICATION

OutBack Power Systems offers an optional three year extension to the standard two year limited warranty. Purchase of extended warranty coverage is available on products listed below provided conditions shown are met. Extended warranty coverage must be purchased within 90 days of the original sale of the product covered.

| PRODUCT | REQUIRED SURGE PROTECTION     | EXTENDED WARRANTY COST |
|---------|-------------------------------|------------------------|
| FX2024  | AC Input; AC Output, DC Input | \$300.00               |
| FX2048  | AC Input; AC Output, DC Input | \$300.00               |
| MX60    | DC Input; DC Output           | \$100.00               |
| MATE    | NA                            | \$50.00                |
| HUB 4   | NA                            | \$35.00                |
| HUB 10  | NA                            | \$50.00                |

| Products Covered | Serial Number | Extended Warranty Cost |
|------------------|---------------|------------------------|
|                  |               |                        |
|                  |               |                        |
|                  |               |                        |
|                  |               | Total                  |

Send check or money order payable to OutBack Power Systems. Include a completed copy of this application and send to:

.....

**FROM**

.....  
.....  
.....  
.....  
.....

**Postage  
Required**



19009 62nd Ave NE  
Arlington, WA 98223  
USA